

**PARKE**

WOOD  
MEETS  
TECHNOLOGY



FLOORING CATALOG

**PARKE KATALOG**



### **Ahşap teknolojiyle buluşuyor, yaşam alanları yenileniyor!**

Doğadan izler taşıyan AGT Parke Serileri, yeniliği yaşam alanlarınıza getirir. Son teknolojiler kullanılarak üretilen parkeler teknik detaylarıyla da fark yaratır.

Farklı zevk ve beklentilere hitap eden geniş ürün skalasıyla her mekana özgün tasarımlar sunar. Zengin doku ve dekor çeşitleri arasından size en uygun olanı seçin, mekanınızda doğayı hissedin!

Yeniliğin öncüsü olan AGT'nin parke serilerini keşfetmeye hazır mısınız?

### **Wood meets technology, living spaces are being renovated!**

*AGT Flooring Series, that has traces of nature, brings innovation to your living spaces. All floorings produces with latest technologies of AGT and also make a difference with their technical details. They all offer unique designs to any place with a wide product range that appeal to various tastes and expectations. Choose the one that best suits for you from a variety of rich texture and decor, and feel the nature in your space!*

*Are you ready to explore AGT's flooring range, a pioneer of innovation?*

# AGT PARKE TEKNOLOJİK ÖZELLİKLER

## AGT FLOORING TECHNOLOGICAL FEATURES



**ANTİSTATİK**  
ANTISTATIC

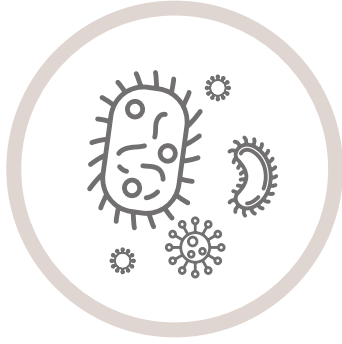

**ANTİBAKTERİYEL**  
ANTIBACTERIAL



**HIZLI VE KOLAY MONTAJ**  
FAST AND EASY ASSEMBLY



**ÇEVRE DOSTU**  
ENVIRONMENTALLY FRIENDLY

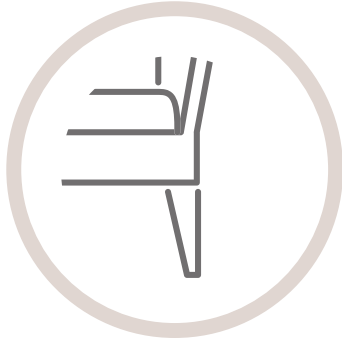

**AŞINMAYA KARŞI**  
DAYANIKLI  
ABRASION RESISTANT





**YERDEN ISITMAYA UYGUN**  
*SUITABLE FOR UNDERFLOOR  
HEATING*



**KOLAY TEMİZLENİR,  
HİJYENİKTİR**  
*EASILY CLEANED,  
MAINTAINED AND HYGENIC*



**UV IŞINLARINA DAYANIKLI**  
*RESISTANT TO UV RAYS*



**LEKE TUTMAZ**  
*STAIN RESISTANT*



**GIDA TEMASINA UYGUN**  
*SUITABLE FOR FOOD  
CONTACT*

# NEDEN AGT PARKE? WHY AGT FLOORING?

## GREENGUARD SERTİFİKASI

AGT Parke Serileri, daha sağlıklı iç mekanlar oluşturulmasına katkı sağlayan Greenguard sertifikasına sahiptir. Greenguard sertifikası, iç mekan faaliyetlerinde kullanılan ürünlerin içinde bulunan kimyasal maddelerin iç mekanın havasının verimi bakımından belirlenen sınır değerleri kapsamında olduğunu gösteren bir sertifikadır.

## GREENGUARD CERTIFICATION

*AGT Flooring Series has the Greenguard certificate, which contributes to the creation of healthier interiors. The Greenguard certificate is a certificate that shows that the chemical substances in the products used in indoor activities are within the limit values determined in terms of the efficiency of the indoor air.*



## DOĞADAN BİR PARÇA

AGT Parke Serileri, istediğiniz doğal görünümü sunar. Parkelerin eşsiz yüzeyi sayesinde, yaşam alanlarında ağaç dokusunu ve doğa hissiyatını yaratırsınız.

## A PIECE FROM NATURE

*AGT Flooring Series give a beautiful natural look you are aiming for. Thanks to the unique surface of AGT Floorings you can create the tree texture and the good nature vibes at living spaces.*

## SÜRDÜRÜLEBİLİR FİKİRLER

AGT, üretimde kullandığı ham maddeyi sürdürülebilir yönetilen ve %100 geri dönüştürülebilir ağaç ve ağaç formlarından elde etmektedir. AGT Biyokütle Enerji Santrali'nde odun atıklarını elektrik enerjisine dönüştürerek sürdürülebilir üretime katkı sağlar.

## SUSTAINABLE IDEAS

*AGT derives the raw material it uses in its production from sustainable managed and 100% recyclable trees and tree forms. AGT contributes to sustainable production by converting wood waste into electrical energy in its own Biomass Power Plant.*



## ANTİBAKTERİYEL

AGT Parke Serileri, özel olarak geliştirilmiş antibakteriyel özelliği sayesinde size ve sevdiklerinize sağlıklı bir yaşam alanı sunar.

## ANTIBACTERIAL

AGT Flooring Series offers you and your loved ones a healthy living space thanks to its specially developed antibacterial feature.

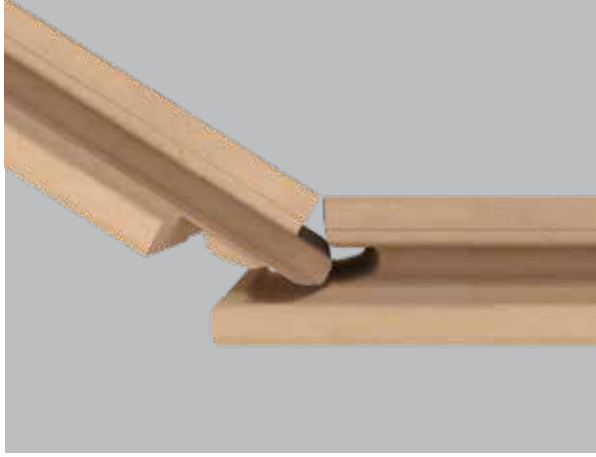
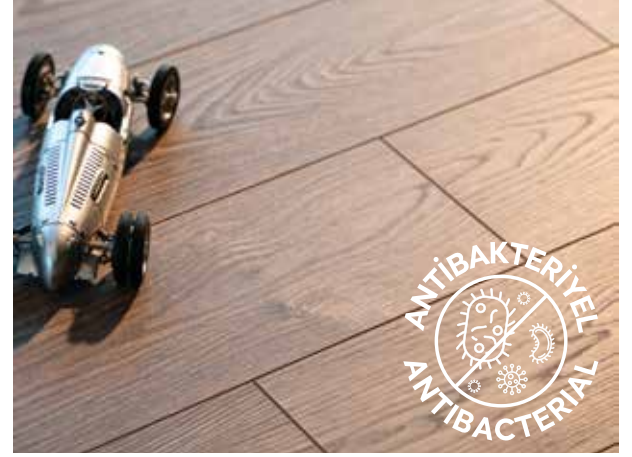

## KOLAY VE HIZLI KURULUM

AGT Parke Serileri sahip olduğu Click to Fit özelliği sayesinde hızlı ve kolayca uygulanır. Böylece hem zamandan tasarruf edilir hem de birbirini sıkı tutan yapısı sayesinde sağlam bir uygulama yapılmış olur.

## EASY AND FAST INSTALLATION

Thanks to its Click to Fit feature, AGT Flooring Series is quickly and easily applied. In this way, it saves time, and a strong laying is made thanks to its structure which holds it tightly together.

## YÜKSEK DAYANIKLILIK

AGT Parke Serileri, yüksek yoğunluklu ağaç liflerinden üretilir ve böylece çok güçlü bir forma ulaşır. Bu teknoloji sayesinde yüksek mukavemet ve çizilmeye karşı direnç sunar ve yıllarca kullanılır.

## HIGH DURABILITY

AGT Flooring Series are produced from high density tree fibers and thus reach a very strong form. Thanks to that technology, it offers high strength and scratch resistance, and has been used for years.



## MOOD

Yeni/New	Modo	14-15
Yeni/New	Mappa	16-17
Yeni/New	Mare	18-19
Yeni/New	Marine	20-21
Yeni/New	Malta	22-23
Yeni/New	Marvel	24-25

<b>Teknik Özellikler/</b> Technical Specifications	26-27
---	-------

## MARCO POLO & MARCO POLO PREMIUM

Yeni/New	Labrador	34-35
Yeni/New	Panama	36-37
Yeni/New	Samoa	38-39
Yeni/New	Florida	40-41
Yeni/New	Azor	42-43
Yeni/New	Colorado	44-45
Yeni/New	Kanada	46-47
Yeni/New	Kaledonya	48-49

<b>Teknik Özellikler/</b> Technical Specifications	50-51
---	-------

<b>Süpergelik Dekor Önerileri/</b> Skirting Decor Suggestions	52-53
--	-------

## YOGA COLLECTION & YOGA COLLECTION PREMIUM

Yeni/New	Yin	58-59
Yeni/New	Namaste	60-61
Yeni/New	Mantra	62-63
Yeni/New	Nidra	64-65
Yeni/New	Noda	66-67
Yeni/New	Asana	68-69
Yeni/New	Karma	70-71
Yeni/New	Prana	72-73

<b>Teknik Özellikler/</b> Technical Specifications	74-75
---	-------

<b>Süpergelik Dekor Önerileri/</b> Skirting Decor Suggestions	76-77
--	-------

## DESIGN BY DEFNE KOZ

### SPARK

Yeni/New	Gold	82-83
Yeni/New	Anthracite	84-85
	Brown	86-87
	Cream	88-89
	Cafe	90-91
	Light Grey	92-93

<b>Teknik Özellikler/</b> Technical Specifications	94-95
---	-------

## EFFECT & EFFECT PREMIUM & EFFECT ELEGANCE

Solaro	102-103
Atlas	104-105
Elbruz	106-107
Logan	108-109
Nirvana	110-111
Rosso	112-113
Everest	114-115
Toros	116-117
Alp	118-119
Pamir	120-121
Ural	122-123
Fuji	124-125
Tibet	126-127
Altay	128-129

<b>Teknik Özellikler/</b> Technical Specifications	130-131
---	---------

<b>Süpergelik Dekor Önerileri/</b> Skirting Decor Suggestions	132-133
--	---------

## CONCEPT NEO

Yeni/New	Portello	138-139
Yeni/New	Lima	140-141
Yeni/New	Pero	142-143
	Scala	144-145
	Moderna	146-147
	Dorino	148-149
	Centro	150-151
	Casella	152-153

<b>Teknik Özellikler/</b> Technical Specifications	154-155
---	---------

<b>Süpergelik Dekor Önerileri/</b> Skirting Decor Suggestions	156
--	-----

## ARMONIA SLIM/LARGE

Minori	162-163
Toskana	164-165
Ravello	166-167
Sorento	168-169
Napoli	170-171
Palermo	172-173

<b>Teknik Özellikler/</b> Technical Specifications	174-175
---	---------

<b>Süpergelik Dekor Önerileri/</b> Skirting Decor Suggestions	176-177
--	---------

## NATURA LINE

Yeni/New	Amazon Meşe/Amazon Oak	182-183
Yeni/New	Ren Meşe/Ren Oak	184-185
	Gala Meşe/Gala Oak	186-187
	Salda Meşe/Salda Oak	188-189
	Rodos	190-191
	Talya	192-193
	Ilgaz Meşe/Ilgaz Oak	194-195
	Kanyon Meşe/Canyon Oak	196-197
	Meriç/Meric	198-199
	Nil/Nile	200-201
	Trend Meşe/Trend Oak	202-203
	Tuna	204-205
	Volga	206-207
	Selge	208-209

<b>Teknik Özellikler/</b> Technical Specifications	210-211
---	---------

<b>Süpergelik Dekor Önerileri/</b> Skirting Decor Suggestions	212-213
--	---------

## PRUVA

Yeni/New	Parima	218-219
Yeni/New	Cenova	220-221
Yeni/New	Alesta	222-223
Yeni/New	Patalya	224-225
	Likya	226-227

<b>Teknik Özellikler/</b> Technical Specifications	228-229
---	---------

<b>Süpergelik Dekor Önerileri/</b> Skirting Decor Suggestions	230-231
--	---------



## NATURA SELECT

<b>Yeni/New</b>	Sia Meşe/Sia Oak	236-237
<b>Yeni/New</b>	Patricia	238-239
	Portofino	240-241
	Porto	242-243
	Morella	244-245
	Lugano	246-247
	Bergama/Pergamon	248-249
	Patara	250-251
	Antalya Çam/Antalya Pine	252-253
	Şiraz Meşe/Shiraz Oak	254-255
	Kanyon Meşe/Canyon Oak	256-257
	Olimpos Meşe/Olympus Oak	258-259
	Natura Meşe/Natura Oak	260-261
	Pasifik Çam/Pacific Pine	262-263
	Gri Meşe/Grey Oak	264-265
	Alara Meşe/Alara Oak	266-267
	Silyon Meşe/Silyon Oak	268-269
	Beyaz Meşe/White Oak	270-271
	Kemer Çam/Kemer Pine	272-273
	Niksar Ceviz/Niksar Walnut	274-275
	<b>Teknik Özellikler/</b> Technical Specifications	276-277
	<b>Süpürgelik Dekor Önerileri/</b> Skirting Decor Suggestions	278-279

## BELLA

<b>Yeni/New</b>	Sardunya	284-285
	Rubio	286-287
	Verona	288-289
	Anemon/Anemone	290-291
	Lilyum/Lilium	292-293
	Akasya/Acacia	294-295
	Vegas	296-297
	Frezya/Freesia	298-299
	Manolya/Magnolia	300-301
	Defne/Daphne	302-303
	Gardenya/Gardenia	304-305
	Begonya/Begonia	306-307
	<b>Teknik Özellikler/</b> Technical Specifications	308-309
	<b>Süpürgelik Dekor Önerileri/</b> Skirting Decor Suggestions	310-311
	<b>SÜPÜRGELİK PROFİLLERİ</b> SKIRTING PROFILES	312-316

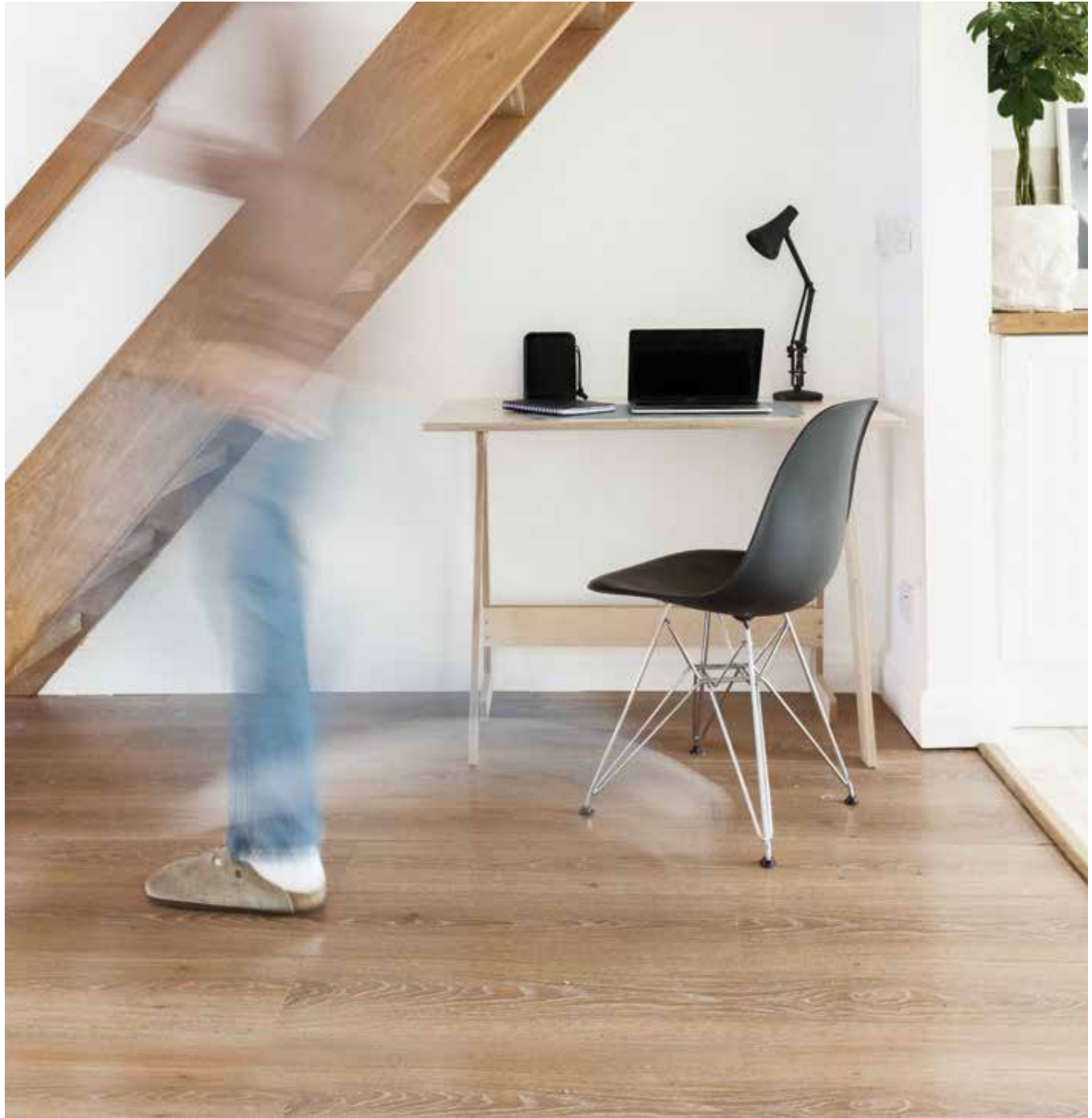



YENİ  
KOLEKSİYON  
NEW  
COLLECTION



10 MM  
FLOORING  
PARKE

**MOOD**



En Width	Boy Length	Kalınlık Thickness	Paket kg Package kg	Paket m <sup>2</sup> Package m <sup>2</sup>
325 mm	1195 mm	10 mm	~17,50	~1,9418





Suya Dayanıklı Mood ile Tanışın!

24 saate kadar su dayanımı özelliğine sahip AGT Mood Koleksiyonu ile tanışın. Nemli iç mekanlarda kaydırmazlık özelliğine sahip Mood Serisi, ahşap ve taş dekorlarıyla her zevke ve ihtiyaca hitap ediyor.

*Meet the water-resistant Mood!*

*Meet the AGT Mood Collection, which has water resistance for up to 24 hours. Mood Series, with its non-slip feature in humid interiors, appeals to all tastes and needs with its wood and stone decors.*

yeni new

modo

Modo ile modunuzu yüksek tutun!  
Modo'nun sıcak ahşap tonları ve rustik  
görünümü ile mekanınızın havası değişsin.

*Keep your mood high with Modo!  
Change the atmosphere of your space with  
Modo's warm wood tones and rustic look.*



yeni new

mappa

Şık dekorun yol haritası çizildi!  
Mappa'nın doğadan ilham alan ahşap dekoruyla  
mekanınıza modern bir hava katın.

*The roadmap of stylish decor has been drawn!  
Add a modern flair to your space with Mappa's  
nature-inspired wooden decor.*





yeni new

mare

Dođal tař tonların sakinlik veren hissi!  
Mare'nin ađık tař tonlarının verdiđi  
ferahlıđı hissedin.

*The calming feeling of natural  
stone tones! Feel the freshness of  
Mare's light stone tones.*

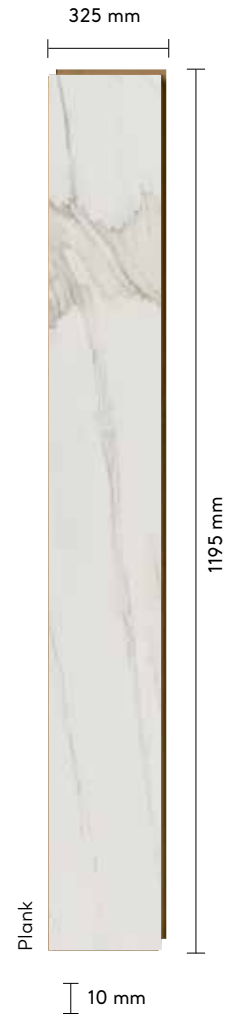

yeni new

# marine

Taş suyla hayat buldu!  
Dalgaların kaya ile buluşmasından ilham  
alan Marine dekoru ile evinizde taş desene  
yer açın.

*Stone came to life with water!  
Make room for the stone pattern in your  
home with the Marine decor, which is  
inspired by the meeting of the waves with  
the rock.*



yeni new

malta

Yaşam alanlarınızda beton görünümü!  
Malta'nın beton etkisi sağlayan dekoru  
ile yaşam alanlarınızda şık ve yalın bir  
görünüme kavuşun.

*Concrete appearance in your living spaces!  
Get a stylish and simple look in your living  
spaces with the concrete effect  
decor of Malta.*

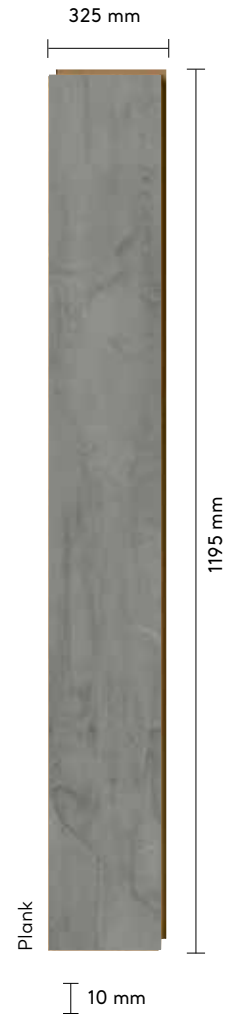



yeni new

marvel

Zeminde sıradışı bir deneyime hazırlanın!  
Marvel'ın koyu taş tonlarının sağladığı  
solistike görünümün tadını çıkarın.

*Get ready for an extraordinary  
experience on the ground!  
Enjoy the sophisticated look provided  
by Marvel's dark stone hues.*





## MOOD TEKNİK ÖZELLİKLER MOOD TECHNICAL SPECIFICATIONS

ÖZELLİKLER / SPECIFICATIONS	STANDART / STANDARD	SONUÇLAR / RESULTS
Elemanlar arası kalınlık farkı <i>Thickness difference between elements</i>	EN 13329	T ortalama < 0,50 mm t max-t min < 0,50 mm <i>T average &lt; 0,50 mm t max-t min &lt; 0,50 mm</i>
Aşınma dayanımı (AC4) <i>Abrasion Resistance (AC4)</i>	EN 13329	Devir > 4000 <i>Cycle &gt; 4000</i>
Aşınma sınıfı <i>Abrasion Class</i>	EN 13329	32. Sınıf <i>32. Class</i>
Elemanın baş kısım gönye sapması <i>Deviation from squareness of element</i>	EN 13329	Q max < 0,2mm
Yüzey tabakasının uzunluğu <i>Length tolerance</i>	EN 13329	l < 1500mm l fark < 0,5mm <i>l &lt; 1500mm l difference &lt; 0,5mm</i>
Yüzey tabakasının genişliği <i>Width tolerance</i>	EN 13329	W ortalama fark 0,10mm w max- w min < 0,20mm <i>W average difference 0,10mm w max- w min &lt; 0,20mm</i>
Kılıcına dönme miktarı <i>Edgewise bending</i>	EN 13329	0,30 mm
Elemanın yüzey düzgünlüğü <i>Surface smoothness</i>	EN 13329	Fw içbükey < %0,15 fw dışbükey < %0,20 F1 içbükey < %0,50 fl dışbükey < %1,00 <i>Fw concave &lt; %0,15 fw convex &lt; %0,20 F1</i> <i>concave &lt; %0,50 fl convex &lt; %1,00</i>
Elemanlar arası açıklık <i>Space between elements</i>	EN 13329	O ortalama < 0,15mm o max 0,15mm <i>O avergae &lt; 0,15mm o max 0,15mm</i>
Elemanlar arası yükseklik farkı <i>Height difference between elements</i>	EN 13329	H ortalama < 0,10mm H max < 0,15mm <i>H avergae &lt; 0,10mm H max &lt; 0,15mm</i>
Yüzey sağlamlığı <i>Surface soundness</i>	EN 13329	AC4 ≥ 1,25 N/mm <sup>2</sup>
Işık haslığı <i>Light fastness</i>	EN ISO 4892 - 2:200	EN 20105 - A02'ye göre gri ölçekte ≥ 4 maruz kalmayan ve maruz kalan örnek parça arasındaki renk kontrastı <i>Colour contrast between unexposed and exposed sample part ≥ 4 of grey scale according to EN 20105 - A02</i>
Çarpma mukavemeti <i>Impact resistance</i>	EN 13329	32. sınıf için IC2 <i>IC2 for 32th class</i>
Koltuk tekerleği etkisi <i>Determination of the effect of a castor chair</i>	EN 425	Görünümde bir değişiklik veya zarar olmayacak <i>No change or damage on appearance should occur</i>
Çizilme mukavemeti (N) <i>Scratch resistance (N)</i>	EN438-2	≥ 3,5 N

ÖZELLİKLER / SPECIFICATIONS	STANDART / STANDARD	SONUÇLAR / RESULTS
Mobilya ayağı etkisi <i>Determination of the effect of a castor furniture</i>	EN 424	Görülebilir zarar olmamalıdır. <i>No visible damage should occur</i>
Sıcak kaplara dayanıklılık <i>Resistance to hot pots</i>	EN 438-2	Sınıf 4 / Class 4
Sigara ateşine karşı dayanıklılık <i>Resistance to cigarette burns fire</i>	EN 13329	Sınıf 4 / Class 4
Su buharına karşı dayanıklılık <i>Resistance to water vapor</i>	EN 438-2	Sınıf 4 / Class 4
Leke tutmaya karşı dayanıklılık <i>Stain resistance</i>	EN 438-2	Sınıf 5 / Class 5
24 saat suda şişme <i>24 hours swelling in thickness</i>	EN 13329	<%18
Yoğunluk <i>Density</i>	EN 323	850-900 Kg/m <sup>3</sup>
Eğilme dayanımı <i>Bending strenght</i>	EN 317	40 N/mm <sup>2</sup>
Elastikiyet modülü <i>Modulus of elasticity</i>	EN 310	3500 N/mm <sup>2</sup>
Çekme dayanımı <i>Vertical internal bond</i>	EN 319	≥1,20 N/mm <sup>2</sup>

## AŞINMA SINIFLARI/ABRASION CLASSES

MOOD	KONUTLARDA / HOUSES			OFİSLERDE / OFFICES		
	Az / Low	Orta / Medium	Yoğun / High	Az / Low	Orta / Medium	Yoğun / High
	21	22	23	31	<b>32</b>	33
	AC1	AC2	AC3	<b>AC4</b>	AC5	
Ortalama aşınma değeri / Average abrasion value	> 900	>1500	>2000	<b>&gt;4000</b>	>6000	

**Renkler basılı ve dijital kataloglarda farklılık gösterebilir. Lütfen, satış noktalarımızda bulunan gerçek ürünler ile karşılaştırınız.**

*Colors may vary in digital and printed catalogs. Please compare with the actual products in the sales points.*



## MOOD DEKORLAR

MOOD DECORS

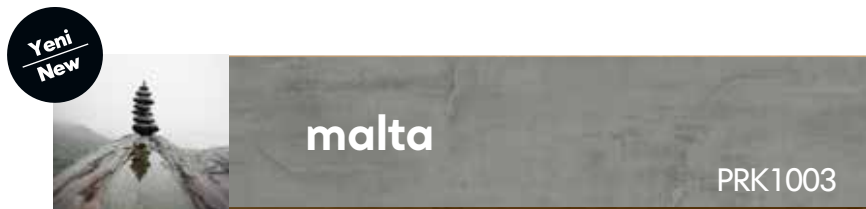
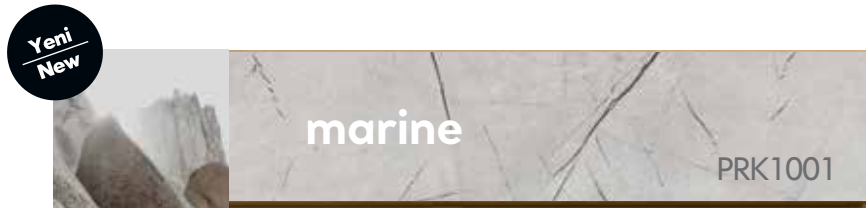
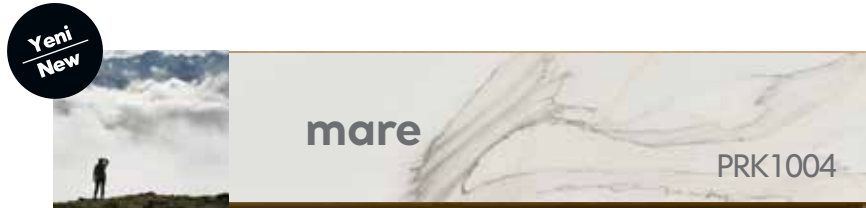
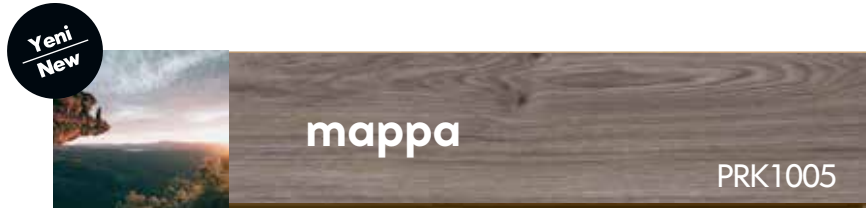



YENİ  
KOLEKSİYON  
NEW  
COLLECTION



8-12 MM  
FLOORING  
PARKE

MARCO  
POLO



	En Width	Boy Length	Kalınlık Thickness	Paket kg Package kg	Paket m <sup>2</sup> Package m <sup>2</sup>	Garanti Süresi Warranty	Aşınma Sınıfı Abrasion Class
Marco Polo	191 mm	1200 mm	8 mm	~13,20	~1,8336	20	
Marco Polo Premium UNIFIT <sup>®</sup> PATENTED TECHNOLOGY	189 mm	1195 mm	12 mm	~14,60	~1,3551	25	







### Bir Keşfin Hikayesi

Marco Polo'nun serüveninden ilhamla oluşturduğumuz;  
büyük liman şehirlerinden ismini alan, muhteşem  
ahşap yüzeyi, koyu ve açık renk geçişleriyle mekanlarınızda  
güçlü kontrast etkisi yaratacak,  
bambaşka bir tasarım macerasına yelken açıyoruz.

### *A Story of Discovery*

Inspired by the adventure of Marco Polo; We are sailing on a  
completely different design adventure, named after  
the big port cities, that will create a strong contrast effect in  
your spaces with its magnificent wooden surface,  
dark and light color transitions.

yeni new

labrador

Mekanına farklı bir boyut kat!  
Renklerin doğayla iç içe geçtiği içinizi  
ısıtacak dekoru evlerinize çağırın.

*Invite the decor to your homes that  
will warm you up, where colors are  
intertwined with nature.*



yeni new

panama

Panama sahillerinin enerjisi!  
Panama sahillerinin ışıltılı enerjisini yaşam alanlarınıza taşıyın.

*The energy of the Panama beaches!  
Bring the sparkling energy of Panama beaches to your living spaces.*



yeni new  
samoaa

Samoa Adaları'nın manzarası...  
Samoa Adaları'nın sislerinin gölgesindeki  
manzarayı evlerinize taşıyın.

*The view of the Samoan Islands...  
Bring the scenery under the shadow of the  
mists of Samoan Islands to your homes.*





yeni new

# florida

Florida sahillerinin esintisi!  
Florida sahillerinin gri-beyaz toprak tonlarından esinlenerek üretilmiş parkemiz ile sahil havasını evinizde hissedin.

*The breeze of Florida beaches!  
Feel the beach air at home with our flooring inspired by the gray-white earth tones of Florida beaches.*





yeni new

azor

Azor adalarının ritmini dinleyin!  
Denizin selamladığı, Azor Adaları'na  
komşu ormanlardan ilham alınarak  
üretilen ahşabın ritmine bırakın kendinizi.

*Listen to the rhythm of the Azores!  
Immerse yourself in the rhythm of wood  
produced by the sea, inspired by the  
forests adjacent to the Azores.*



yeni new

# colorado

Colorado isminden ilhamla!  
İsminden ilham alınarak tasarlanan,  
renkli toprakları çağrıştıran büyüleyici  
tonuyla Colorado ile tanışın.

*Inspired by the name Colorado!  
Meet Colorado with its enchanting tone,  
inspired by its name, evoking colorful  
lands.*



yeni new

# kanada

Beyazlar şehri Kanada!  
Güçlü iklimi ve etkileyici doğasından  
ilhamla tasarlanan beyazlar içindeki  
özgün dokunuşu hisset.

*Canada, the city of whites!  
Feel the original touch in whites designed  
with inspiration from the cold climate.*



yeni new

kaledonya

Adım adım Kaledonya!  
Kaledonya adasının sıcak toprak tonunu  
adımlarınızda hissedin.

*Caledonia step by step!  
Feel the warm earth tone of the island of  
Caledonia in your steps.*





# MARCO POLO/ MARCO POLO PREMIUM TEKNİK ÖZELLİKLER

## MARCO POLO/MARCO POLO PREMIUM TECHNICAL SPECIFICATIONS

ÖZELLİKLER / SPECIFICATIONS	STANDART / STANDARD	SONUÇLAR / RESULTS
Elemanlar arası kalınlık farkı <i>Thickness difference between elements</i>	EN 13329	T ortalama< 0,50 mm t max-t min<0,50 mm T average< 0,50 mm t max-t min<0,50 mm
Aşınma dayanımı <i>Abrasion Resistance</i>	EN 438	Marco Polo: Devir>4000 Cycle>4000 Marco Polo Premium: Devir>6000 Cycle>6000
Elemanın baş kısım gönye sapması <i>Deviation from squareness of element</i>	EN 13329	Q max< 0,2mm
Yüzey tabakasının uzunluğu <i>Length tolerance</i>	EN 13329	l<1500mm l fark<0,5mm l<1500mm l difference<0,5mm
Yüzey tabakasının genişliği <i>Width tolerance</i>	EN 13329	W ortalama fark 0,10mm w max- w min<0,20mm W average difference 0,10mm w max- w min<0,20mm
Kılıcına dönme miktarı <i>Edgewise bending</i>	EN 13329	0,30 mm
Elemanın yüzey düzgünlüğü <i>Surface smoothness</i>	EN 13329	Fw içbükey <%0,15 fw dışbükey <%0,20 F1 içbükey <%0,50 fl dışbükey <%1,00 Fw concave <%0,15 fw convex <%0,20 F1 concave <%0,50 fl convex <%1,00
Elemanlar arası açıklık <i>Space between elements</i>	EN 13329	O ortalama<0,15mm o max 0,15mm O average<0,15mm o max 0,15mm
Elemanlar arası yükseklik farkı <i>Height difference between elements</i>	EN 13329	H ortalama< 0,10mm H max<0,15mm H average< 0,10mm H max<0,15mm
Yüzey sağlamlığı <i>Surface soundness</i>	EN 13329	AC4 / AC5 ≥1,25 N/mm <sup>2</sup>
Çizilme mukavemeti (N) <i>Scratch resistance</i>	EN 438	>3,5
Işık haslığı <i>Light fastness</i>	EN ISO 4892 - 2:200	EN 20105 - A02'ye göre gri ölçekte ≥4 maruz kalmayan ve maruz kalan örnek parça arasındaki renk kontrastı Colour contrast between unexposed and exposed sample part ≥ 4 of grey scale according to EN 20105 - A02
Çarpma mukavemeti <i>Impact resistance</i>	EN 13329	32. sınıf için IC2 / IC2 for 32th class 33. sınıf için IC3 / IC3 for 33th class
Koltuk tekerleği etkisi <i>Determination of the effect of a castor chair</i>	EN 425	Görünümde bir değişiklik veya zarar olmayacak No change or damage on appearance should occur
Mobilya ayağı etkisi <i>Determination of the effect of a castor furniture</i>	EN 424	Görülebilir zarar olmamalıdır. No visible damage should occur
Sıcak kaplara dayanıklılık <i>Resistance to hot pots</i>	EN 13329	Sınıf 4 / Class 4
Sigara ateşine karşı dayanıklılık <i>Resistance to cigarette burns fire</i>	EN 13329	Sınıf 4 / Class 4
Su buharına karşı dayanıklılık <i>Resistance to water vapor</i>	EN 13329	Sınıf 4 / Class 4
Leke tutmaya karşı dayanıklılık <i>Stain resistance</i>	EN 13329	Sınıf 5 / Class 5
24 saat suda şişme <i>24 hours swelling in thickness</i>	EN 13329	<%18
Yoğunluk <i>Density</i>	EN 323	850-900 kg/m <sup>3</sup>
Eğilme dayanımı <i>Bending strenght</i>	EN 317	40 N/mm <sup>2</sup>
Elastikiyet modülü <i>Modulus of elasticity</i>	EN 310	3500 N/mm <sup>2</sup>
Çekme dayanımı <i>Vertical internal bond</i>	EN 319	≥1,2 N/mm <sup>2</sup>

## AŞINMA SINIFLARI/ABRASION CLASSES

MARCO POLO	KONUTLARDA / HOUSES			OFİSLERDE / OFFICES		
	Az / low	Orta / Medium	Yoğun / High	Az / low	Orta / Medium	Yoğun / High
	21	22	23	31	<b>32</b>	33
	AC1	AC2	AC3	<b>AC4</b>	AC5	
Ortalama aşınma değeri / Average abrasion value	> 900	>1500	>2000	<b>&gt;4000</b>	>6000	

## AŞINMA SINIFLARI/ABRASION CLASSES

MARCO POLO PREMIUM	KONUTLARDA / HOUSES			OFİSLERDE / OFFICES		
	Az / low	Orta / Medium	Yoğun / High	Az / low	Orta / Medium	Yoğun / High
	21	22	23	31	32	<b>33</b>
	AC1	AC2	AC3	AC4	<b>AC5</b>	
Ortalama aşınma değeri / Average abrasion value	> 900	>1500	>2000	>4000	<b>&gt;6000</b>	



## MARCO POLO DEKORLAR

MARCO POLO DECORS

Yeni  
New



Yeni  
New



Yeni  
New



Yeni  
New



Yeni  
New



Yeni  
New



Yeni  
New



Yeni  
New



## MARCO POLO SÜPÜRGELİK DEKORLAR

MARCO POLO  
SKIRTING DECORS



YENİ  
KOLEKSİYON  
NEW  
COLLECTION



8-12 MM  
FLOORING  
PARKE

Yöğa  
COLLECTION



	En Width	Boy Length	Kalınlık Thickness	Paket kg Package kg	Paket m <sup>2</sup> Package m <sup>2</sup>	Garanti Süresi Warranty	Aşınma Sınıfı Abrasion Class
Yoga Collection	191 mm	1200 mm	8 mm	~13,20	~1,8336	20	
Yoga Collection Premium	189 mm	1195 mm	12 mm	~14,60	~1,3551	25	







### Mükemmel Uyumu Yakala

Derin bir nefes alın, AGT Yoga Koleksiyonu'nun dengeleyici tonlarıyla rahatlayın. Huzur verici ve modern Yoga Serisi ile dekorasyonda uyumu, yaşam alanınızda dengeyi yakalayın!

### *Find The Perfect Fit*

*Take a deep breath and relax with the balancing tones of the AGT Yoga Collection. Find harmony in decoration and balance in your living space with the peaceful and modern Yoga Series!*

yeni new

yin

Mekanındaki enerji akışı!  
Yin yogadan alınan ilhamla, mekanınızda  
dinginlięi ve enerji akışını hissedin.

*The energy flow in your space!  
Feel the serenity and energy flow in your  
space, inspired by yin yoga.*

# Yoga

COLLECTION

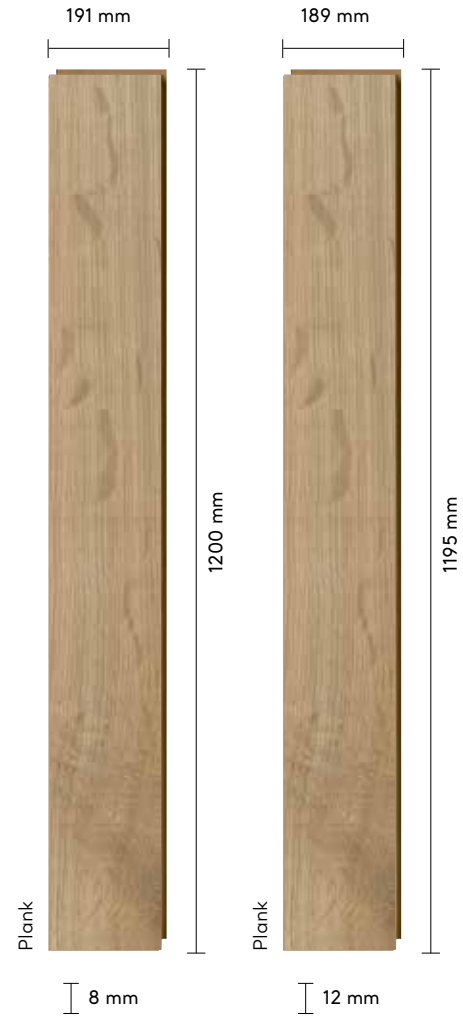

yeni new

namaste

Mekanınızda iyi hissedin!  
Namastenin sevgi dolu enerjisiyle  
mekanınıza iyiliği ve güzelliği taşıyın.

*Feel good in your space!  
Bring goodness and beauty into your space  
with the loving energy of Namaste.*

# Yoga

COLLECTION

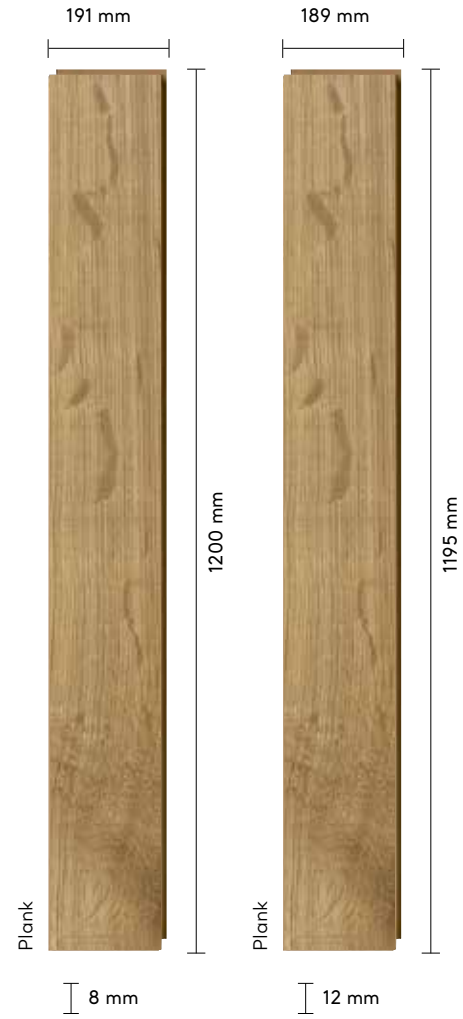

yeni new

mantra

Özgürlüğü hissettiren dekor!  
Zihninizi özgür bırakmanıza yardımcı olan  
dekorla mekanınızda hafifliği hissedin.

*Decor that makes you feel freedom!  
Feel the lightness in your space with the  
decor that helps you set your mind free.*

# Yoga

COLLECTION

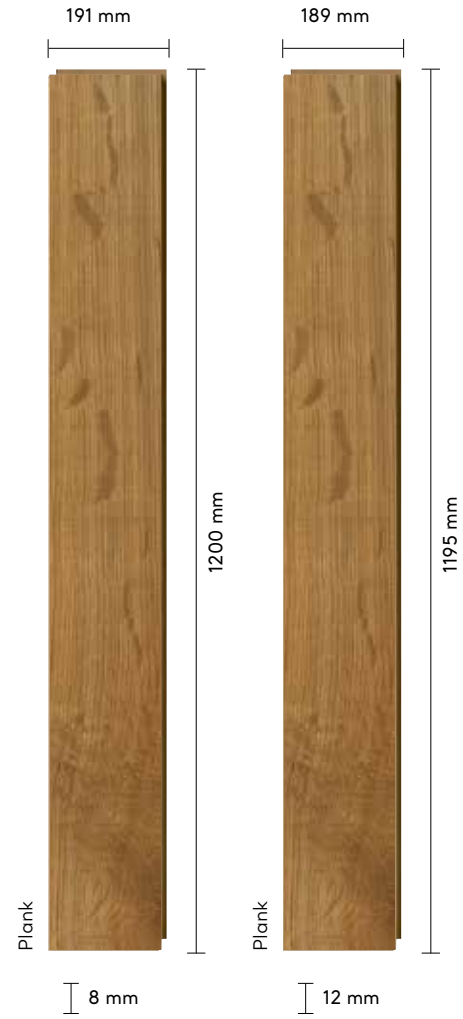

yeni new

nidra

Yaşam alanınızdaki sakin aura!  
Sakin dekorun huzur dolu havasıyla  
benliğinizi uyandırın.

*The calm aura in your living space!  
Awaken your self with the serene  
atmosphere of the tranquil decor.*



# Yoga

COLLECTION

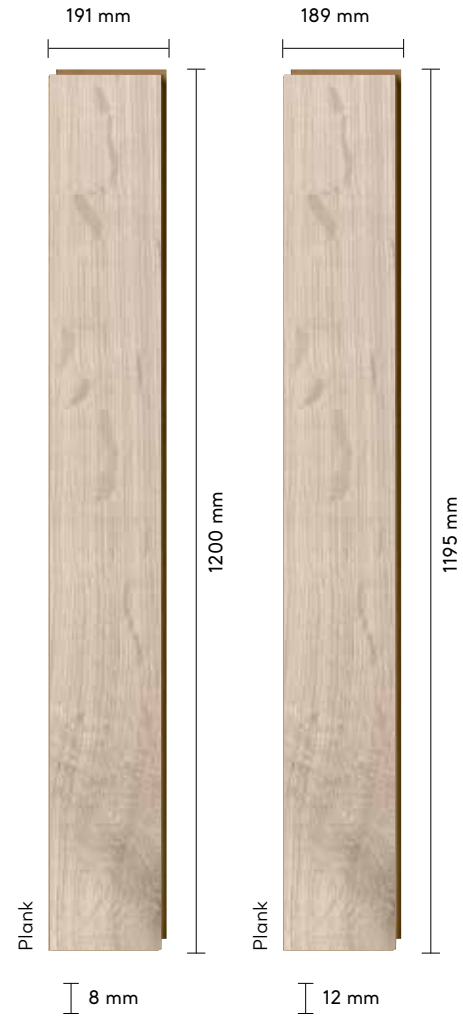



yeni new

noda

Dekorun huzurunu hissedin!  
Yaşam alanınıza huzur ve denge, ruhunuza  
ferahlık getirir.

*Feel the tranquility of the decor!  
It brings peace and balance to your living  
space and refreshes your soul.*

# Yoga

COLLECTION

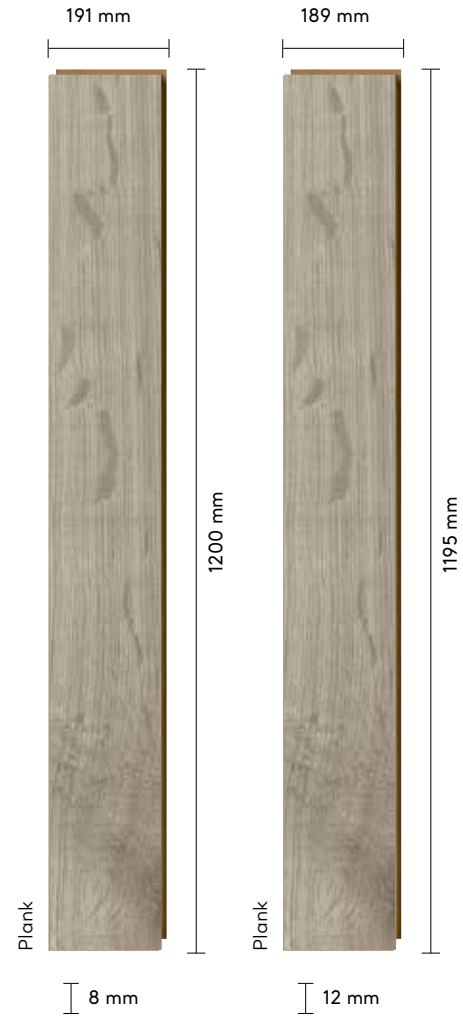

yeni new

asana

Yaşam alanınızdaki pozitif duruş!  
Yoganın pozitif duruşu ile yaşam alanınızda  
enerjiyi yakalayın.

*Positive stance in your living space!  
Catch the energy in your living space with  
the positive posture of yoga.*

# Yoga

COLLECTION

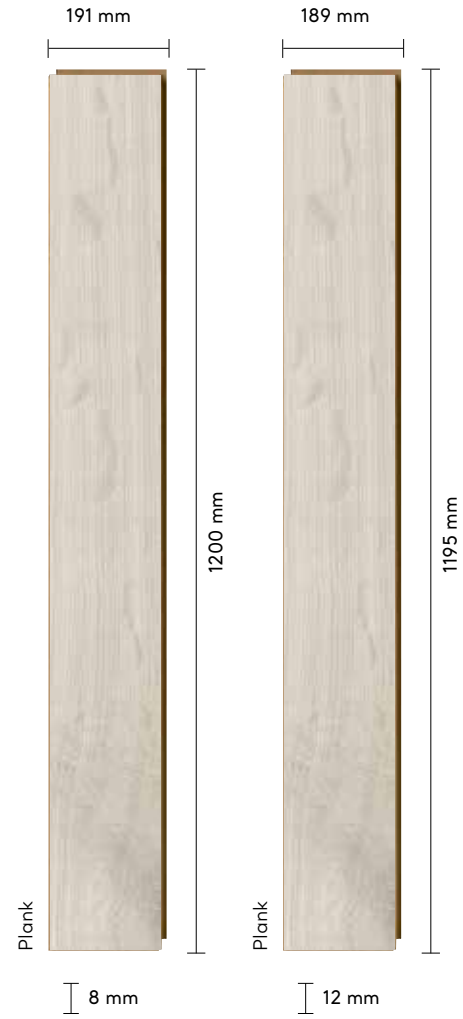

yeni new

karma

İyiliğin dekora dönüşümü!  
Bütün pozitif enerjileri  
yaşam alanınıza çekin.

*Transformation of goodness into decor!  
Attract all positive energies into  
your living space.*

# Yoga

COLLECTION

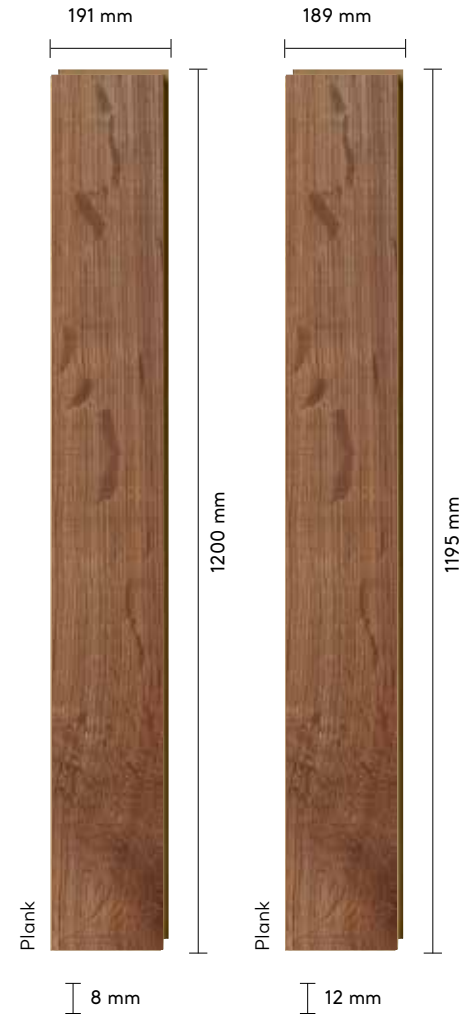

yeni new

prana

Hayat enerjinizin yaşam alanınızdaki hali!  
Canlılığı ve ruhunuzdaki enerjiyi  
yaşam alanınıza yansıtın.

*The state of your life energy in  
your living space!  
Reflect the vitality and the  
energy in your soul into your living space.*



# Yoga

COLLECTION



# YOGA COLLECTION/YOGA COLLECTION PREMIUM TEKNİK ÖZELLİKLER

## YOGA COLLECTION/YOGA COLLECTION PREMIUM TECHNICAL SPECIFICATIONS

ÖZELLİKLER / SPECIFICATIONS	STANDART / STANDARD	SONUÇLAR / RESULTS
Elemanlar arası kalınlık farkı <i>Thickness difference between elements</i>	EN 13329	T ortalama< 0,50 mm t max-t min<0,50 mm <i>T average&lt; 0,50 mm t max-t min&lt;0,50 mm</i>
Aşınma dayanımı <i>Abrasion Resistance</i>	EN 438	Yoga Collection: Devir>4000 Cycle>4000 Yoga Collection Premium: Devir>6000 Cycle>6000
Elemanın baş kısım gönye sapması <i>Deviation from squareness of element</i>	EN 13329	Q max< 0,2mm
Yüzey tabakasının uzunluğu <i>Length tolerance</i>	EN 13329	l <1500mm l fark<0,5mm <i>l &lt;1500mm l difference&lt;0,5mm</i>
Yüzey tabakasının genişliği <i>Width tolerance</i>	EN 13329	W ortalama fark 0,10mm w max- w min<0,20mm <i>W average difference 0,10mm w max- w min&lt;0,20mm</i>
Kılıcına dönme miktarı <i>Edgewise bending</i>	EN 13329	0,30 mm
Elemanın yüzey düzgünlüğü <i>Surface smoothness</i>	EN 13329	Fw içbükey <%0,15 fw dışbükey <%0,20 F1 içbükey <%0,50 fl dışbükey <%1,00 Fw concave <%0,15 fw convex <%0,20 F1 concave <%0,50 fl convex <%1,00
Elemanlar arası açıklık <i>Space between elements</i>	EN 13329	O ortalama<0,15mm o max 0,15mm <i>O average&lt;0,15mm o max 0,15mm</i>
Elemanlar arası yükseklik farkı <i>Height difference between elements</i>	EN 13329	H ortalama< 0,10mm H max<0,15mm <i>H average&lt; 0,10mm H max&lt;0,15mm</i>
Yüzey sağlamlığı <i>Surface soundness</i>	EN 13329	AC4 / AC5 ≥1,25 N/mm <sup>2</sup>
Çizilme mukavemeti (N) <i>Scratch resistance</i>	EN 438	>3,5
Işık haslığı <i>Light fastness</i>	EN ISO 4892 - 2:200	EN 20105 - A02'ye göre gri ölçekte ≥4 maruz kalmayan ve maruz kalan örnek parça arasındaki renk kontrastı <i>Colour contrast between unexposed and exposed sample part ≥ 4 of grey scale according to EN 20105 - A02</i>
Çarpma mukavemeti <i>Impact resistance</i>	EN 13329	32. sınıf için IC2 / IC2 for 32th class 33. sınıf için IC3 / IC3 for 33th class
Koltuk tekerleği etkisi <i>Determination of the effect of a castor chair</i>	EN 425	Görünümde bir değişiklik veya zarar olmayacak <i>No change or damage on appearance should occur</i>
Mobilya ayağı etkisi <i>Determination of the effect of a castor furniture</i>	EN 424	Görülebilir zarar olmamalıdır. <i>No visible damage should occur</i>
Sıcak kaplara dayanıklılık <i>Resistance to hot pots</i>	EN 13329	Sınıf 4 / Class 4
Sigara ateşine karşı dayanıklılık <i>Resistance to cigarette burns fire</i>	EN 13329	Sınıf 4 / Class 4
Su buharına karşı dayanıklılık <i>Resistance to water vapor</i>	EN 13329	Sınıf 4 / Class 4
Leke tutmaya karşı dayanıklılık <i>Stain resistance</i>	EN 13329	Sınıf 5 / Class 5
24 saat suda şişme <i>24 hours swelling in thickness</i>	EN 13329	<%18
Yoğunluk <i>Density</i>	EN 323	850-900 kg/m <sup>3</sup>
Eğilme dayanımı <i>Bending strenght</i>	EN 317	40 N/mm <sup>2</sup>
Elastikiyet modülü <i>Modulus of elasticity</i>	EN 310	3500 N/mm <sup>2</sup>
Çekme dayanımı <i>Vertical internal bond</i>	EN 319	≥1,2 N/mm <sup>2</sup>

## AŞINMA SINIFLARI/ABRASION CLASSES

YOGA COLLECTION	KONUTLARDA / HOUSES			OFİSLERDE / OFFICES		
	Az / low	Orta / Medium	Yoğun / High	Az / low	Orta / Medium	Yoğun / High
	21	22	23	31	<b>32</b>	33
	AC1	AC2	AC3	<b>AC4</b>	AC5	
Ortalama aşınma değeri / Average abrasion value	> 900	>1500	>2000	<b>&gt;4000</b>	>6000	

## AŞINMA SINIFLARI/ABRASION CLASSES

YOGA COLLECTION PREMIUM	KONUTLARDA / HOUSES			OFİSLERDE / OFFICES		
	Az / low	Orta / Medium	Yoğun / High	Az / low	Orta / Medium	Yoğun / High
	21	22	23	31	32	<b>33</b>
	AC1	AC2	AC3	AC4	<b>AC5</b>	
Ortalama aşınma değeri / Average abrasion value	> 900	>1500	>2000	>4000	<b>&gt;6000</b>	

## YOGA DEKORLAR

YOGA DECORS

Yeni  
New



asana

PRK923

Yeni  
New



nidra

PRK929

Yeni  
New



noda

PRK925

Yeni  
New



yin

PRK930

Yeni  
New



namaste

PRK924

Yeni  
New



mantra

PRK927

Yeni  
New



karma

PRK926

Yeni  
New



prana

PRK928

## YOGA SÜPÜRGELİK

DEKORLAR

YOGA

SKIRTING DECORS









12 MM  
FLOORING  
PARKE

BY DEFNE KOZ

AGT DESIGN



En Width	Boy Length	Kalınlık Thickness	Paket kg Package kg	Paket m <sup>2</sup> Package m <sup>2</sup>
190 mm	1200 mm	12 mm	~14,80	~1,3680







## Dođal mı, insan üretimi mi?

İnsan üretimi ve dođal arasındaki denge beni her zaman meraklandırmıştır. Ben de dođal ahşap desenlerini kullanmak yerine, insanın yaratıcılığı ile doğanın güzelliğinin bir araya gelmesinden ilham aldım.

Doğanın ve tasarımın en iyi yanlarını bir araya getirdim. Koleksiyonumda sıcak renkler, zengin dokular, geometrik olmayan organik desenler ve ahşaba ait dođal özelliklerle, özgün desenler ve geniş yelpazedeki dekor çeşitliliği, insan üretimi ürünlerin özellikleri birlikte yer almaktadır.

Desenler, derinlik ve zenginlik hissi yaratılmak üzere tasarlandı. Peki bu koleksiyonlar dođal mı, yoksa insan üretimi mi? Ben "doğanın ilhamı ve tasarımın birlikteliği" olduklarına inanıyorum.

## *Natural or human-made?*

*I am always intrigued by the balance between artificial and natural. Instead of using natural wood patterns, I was inspired by human creativity and the beauty of nature.*

*I combined the best of both worlds. My collection has the natural quality of wood, like warm colors, rich texture, and non-geometric organic patterns, plus all qualities of human-made products, like creative patterns and wide variations of decor.*

*The patterns are designed to create a sense of depth and richness. So, are these collections natural or human-made? I like to think "they are combination of nature inspiration and creative design."*

**Defne Koz**  
DKOZ

yeni new  
gold

Yaşam alanında altın esintileri!  
Defne Koz'un tasarım dekoru ile  
yaşam alanın tarzını yansıtsın.

*Golden breezes in your living space!  
Let it reflect the style of your living  
space with Defne Koz's design  
decor.*



yeni new

anthracite

Mekanındaki cool hava!  
Defne Koz'un yenilikçi dekoru  
ile mekanına modern ve şık bir  
hava kat.

*Cool air in your place!  
Add a modern and stylish  
atmosphere to your space with  
Defne Koz's innovative decor.*

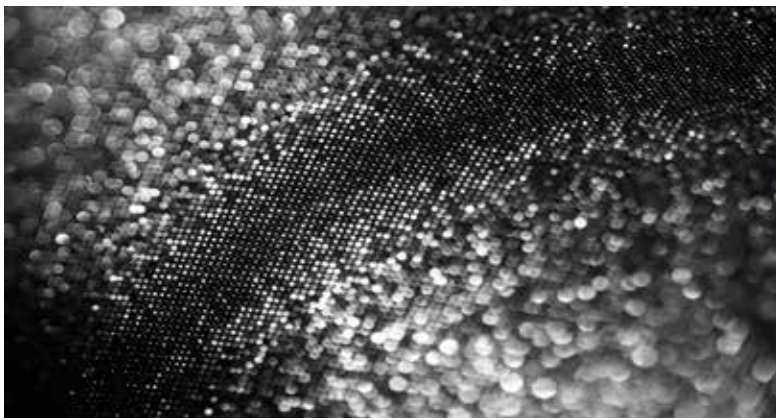
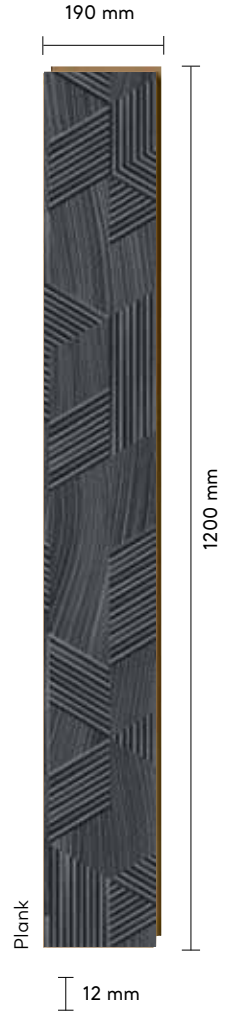

brown

Ahşap damarları  
geometrik çizgilerle bir araya  
getiren zengin bir desen.

*A rich pattern combining wooden  
grains with geometric lines.*





cream

Geniř, etkileyici ve ferah mekanlar için mükemmel bir tercih.

*An excellent choice for large, impressive and spacious spaces.*



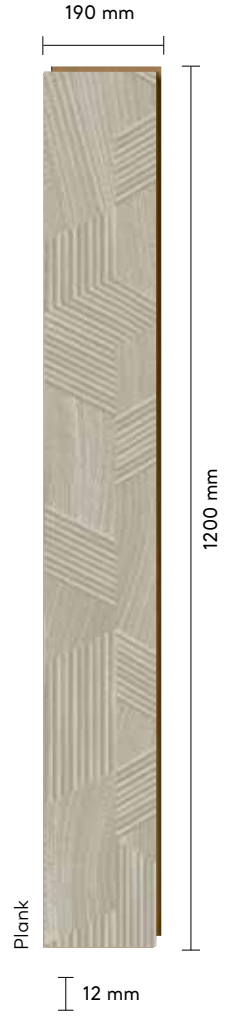

# cafe

Geometrik, estetik ve şık!  
Yaşam alanlarında özlediğimiz  
doğallığı sunar.

*Geometric, aesthetic and chic!  
It offers naturalness  
those we miss at living spaces.*





# light grey

Açık grinin ferah ve iç açıcı etkisinin ahşap damarlarla birleşimi.

*The combination of the fresh and heartwarming effect of light gray with wooden grains.*

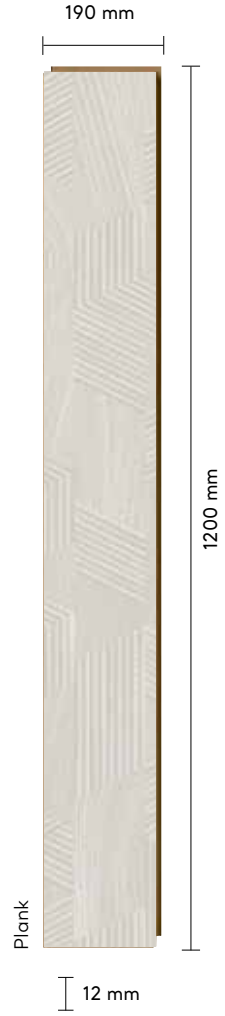

## SPARK TEKNİK ÖZELLİKLER SPARK TECHNICAL SPECIFICATIONS

ÖZELLİKLER / SPECIFICATIONS	STANDART / STANDARD	SONUÇLAR / RESULTS
Elemanlar arası kalınlık farkı <i>Thickness difference between elements</i>	EN 13329	T ortalama < 0,50 mm t max-t min < 0,50 mm T average < 0,50 mm t max-t min < 0,50 mm
Aşınma dayanımı <i>Abrasion Resistance</i>	EN 438	Devir > 4000 Cycle > 4000
Elemanın baş kısım gönye sapması <i>Deviation from squareness of element</i>	EN 13329	Q max < 0,2mm
Yüzey tabakasının uzunluğu <i>Length tolerance</i>	EN 13329	l < 1500mm l fark < 0,5mm l < 1500mm l difference < 0,5mm
Yüzey tabakasının genişliği <i>Width tolerance</i>	EN 13329	W ortalama fark 0,10mm w max- w min < 0,20mm W average difference 0,10mm w max- w min < 0,20mm
Kılıcına dönme miktarı <i>Edgewise bending</i>	EN 13329	0,30 mm
Elemanın yüzey düzgünlüğü <i>Surface smoothness</i>	EN 13329	Fw içbükey < %0,15 fw dışbükey < %0,20 F1 içbükey < %0,50 fl dışbükey < %1,00 Fw concave < %0,15 fw convex < %0,20 F1 concave < %0,50 fl convex < %1,00
Elemanlar arası açıklık <i>Space between elements</i>	EN 13329	O ortalama < 0,15mm o max 0,15mm O average < 0,15mm o max 0,15mm
Elemanlar arası yükseklik farkı <i>Height difference between elements</i>	EN 13329	H ortalama < 0,10mm H max < 0,15mm H average < 0,10mm H max < 0,15mm
Yüzey sağlamlığı <i>Surface soundness</i>	EN 13329	AC4 ≥ 1,25 N/mm <sup>2</sup>
Çizilme mukavemeti (N) <i>Scratch resistance</i>	EN 438	> 3,5
Işık haslılığı <i>Light fastness</i>	EN ISO 4892 - 2:200	EN 20105 - A02'ye göre gri ölçekte ≥ 4 maruz kalmayan ve maruz kalan örnek parça arasındaki renk kontrastı Colour contrast between unexposed and exposed sample part ≥ 4 of grey scale according to EN 20105 - A02
Çarpma mukavemeti <i>Impact resistance</i>	EN 13329	32. sınıf için IC2 IC2 for 32 <sup>th</sup> class
Koltuk tekerleği etkisi <i>Determination of the effect of a castor chair</i>	EN 425	Görünümde bir değişiklik veya zarar olmayacak No change or damage on appearance should occur
Mobilya ayağı etkisi <i>Determination of the effect of a castor furniture</i>	EN 424	Görülebilir zarar olmamalıdır. No visible damage should occur
Sıcak kaplara dayanıklılık <i>Resistance to hot pots</i>	EN 13329	Sınıf 4 / Class 4
Sigara ateşine karşı dayanıklılık <i>Resistance to cigarette burns fire</i>	EN 13329	Sınıf 4 / Class 4
Su buharına karşı dayanıklılık <i>Resistance to water vapor</i>	EN 13329	Sınıf 4 / Class 4
Leke tutmaya karşı dayanıklılık <i>Stain resistance</i>	EN 13329	Sınıf 5 / Class 5
24 saat suda şişme <i>24 hours swelling in thickness</i>	EN 13329	< %18
Yoğunluk <i>Density</i>	EN 323	850-900 kg/m <sup>3</sup>
Eğilme dayanımı <i>Bending strenght</i>	EN 317	40 N/mm <sup>2</sup>
Elastikiyet modülü <i>Modulus of elasticity</i>	EN 310	3500 N/mm <sup>2</sup>
Çekme dayanımı <i>Vertical internal bond</i>	EN 319	≥ 1,2 N/mm <sup>2</sup>

## AŞINMA SINIFLARI/ABRASION CLASSES

SPARK	KONUTLARDA / HOUSES			OFİSLERDE / OFFICES		
	Az / Low	Orta / Medium	Yoğun / High	Az / Low	Orta / Medium	Yoğun / High
	21	22	23	31	32	33
	AC1	AC2	AC3	AC4	AC5	
Ortalama aşınma değeri / Average abrasion value	> 900	>1500	>2000	>4000	>6000	



Renkler basılı ve dijital kataloğlarda farklılık gösterebilir. Lütfen, satış noktalarımızda bulunan gerçek ürünler ile karşılaştırınız.

Colors may vary in digital and printed catalogs. Please compare with the actual products in the sales points.



**AGT DESIGN BY**  
**DEFNE KOZ SPARK DEKORLAR**  
AGT DESIGN BY DEFNE KOZ SPARK DECORS

Yeni  
New

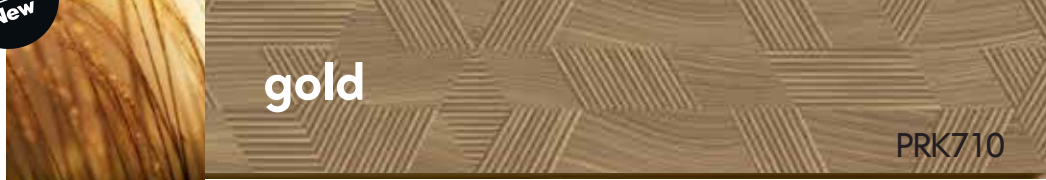

Yeni  
New

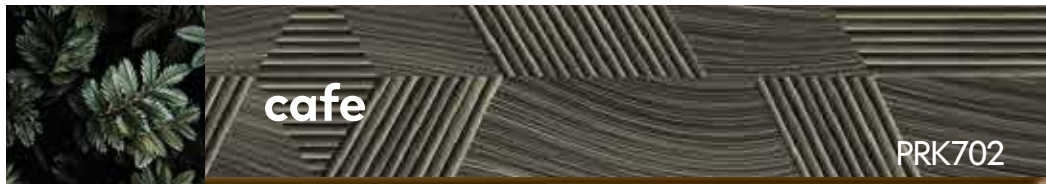









8-12 MM  
FLOORING  
PARKE

EFFECT



	En Width	Boy Length	Kalınlık Thickness	Paket kg Package kg	Paket m <sup>2</sup> Package m <sup>2</sup>	Garanti Süresi Warranty	Aşınma Sınıfı Abrasion Class
Effect	191 mm	1200 mm	8 mm	~13,20	~1,8336	20	AC3
Effect Premium	189 mm	1195 mm	12 mm	~14,60	~1,3551	25	AC3
Effect Elegance	154,5 mm	1195 mm	12 mm	~12	~1,1078	25	AC3





Doğadan ilham alan Effect, Effect Premium ve Effect Elegance Parke Serileri ile yeniliği keşfedin. Farklı ölçü ve tonlardan dilediğinizi seçin, doğayı yaşam alanlarınızda hissedin!

*Experience innovation with the nature-inspired Effect, Effect Premium and Effect Elegance Flooring Series. Choose the best for you from different size and tones, and feel the nature at your living spaces!*



# solaro

Yaşam alanlarına  
estetik dokunuşlar!  
Her adımınızda  
Akdeniz'in sıcak  
tonlarını hissedin.

*Aesthetic touches  
to living spaces!  
Feel the warm tones  
of the Mediterranean  
in your any step.*

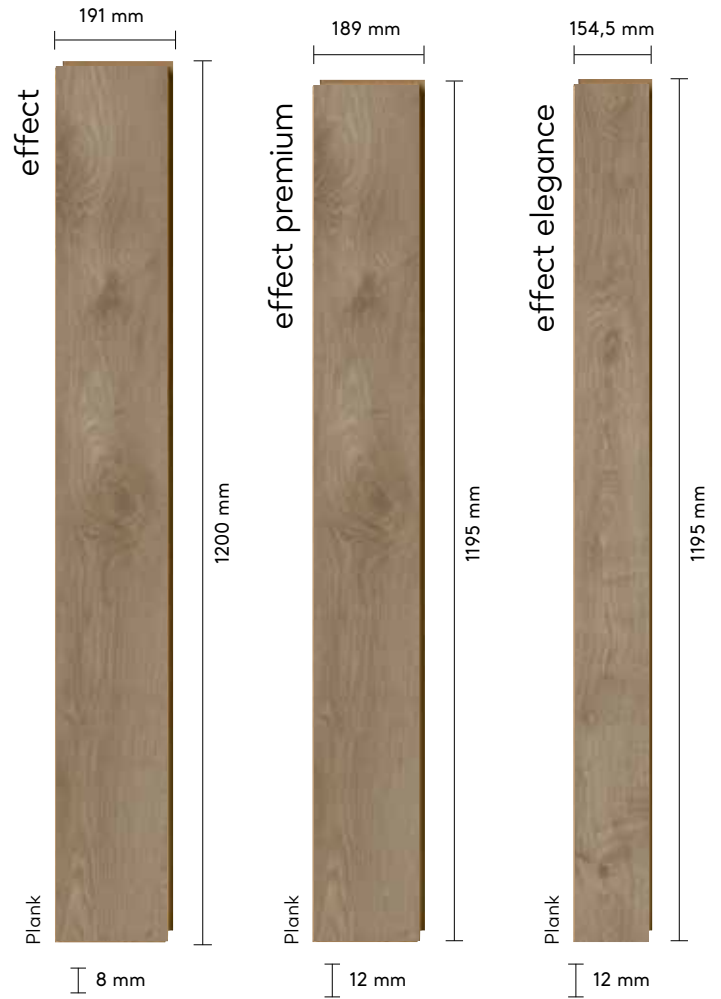

# atlas

Dağların ve vadilerin  
arasında yürüyüş keyfini  
yaşayın, mekanınızda sıcak  
bir atmosfer yaratın.

*Enjoy a unique walk  
between mountains and  
valleys, create a warm  
atmosphere in your place.*





# elbruz

Buzul kaplı zirvelere doğru  
bir yolculuk! Kar kaplı dağların  
güzelliğini mekanınıza taşıyın.

*A journey to the glacial peaks!  
Bring the magical beauty of the  
snow-covered mountains  
to your place.*



logan

Beyaz bulutlar, gri toprak tonlarıyla buluşuyor!  
Yaşam alanlarınızda ferahlığı keşfedin.

*Snow white clouds meet  
grey earth tones!  
Discover the freshness  
in your living spaces.*





# nirvana

Kanada'nın doruklarından  
bir parça. Yeniliğin ve ferahlığın  
zirvesinde yürüyün!

*A piece from Canada's peaks.  
Walk at the peak of innovation  
and refreshment!*

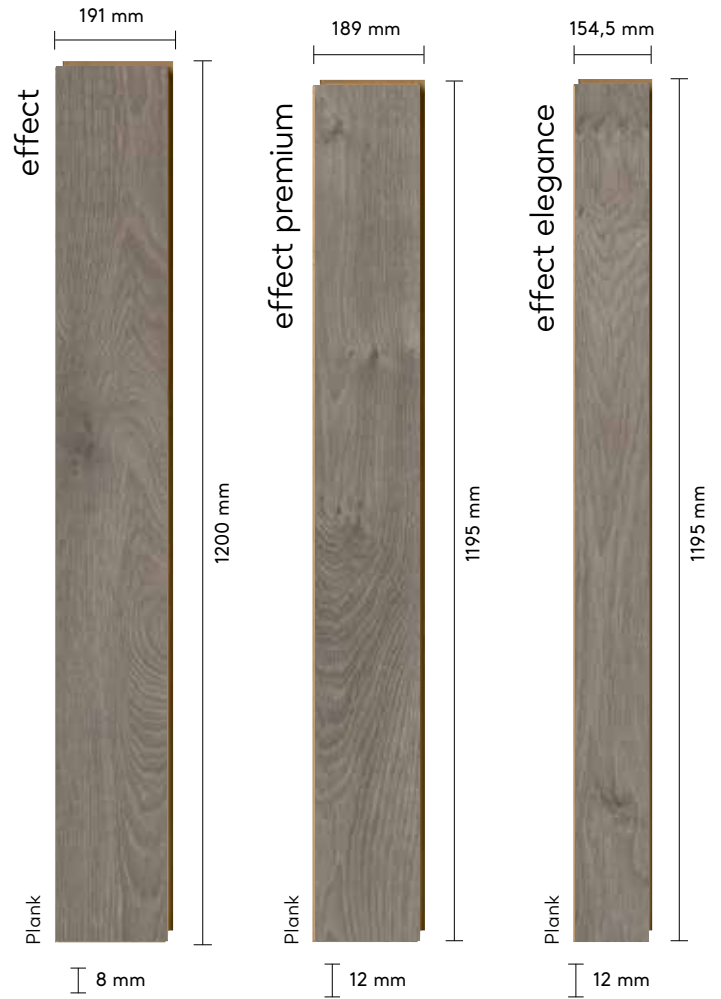



ROSSO

El değmemiş topraklardan  
ilham alan eşsiz bir dekor!  
Gün batımının sıcak esintilerini  
mekanınızda hissedin.

*A unique decor inspired by  
untouched lands! Feel the  
warm breezes of the sunset  
in your space.*





everest

Zirvelerin doęallığı ayaklarınıza serilsin! Hayal ettięiniz yenilięe mekanınızda ulařın.

*Let the naturalness of the peaks lay under your feet! Achieve the innovation you dream of in your space.*

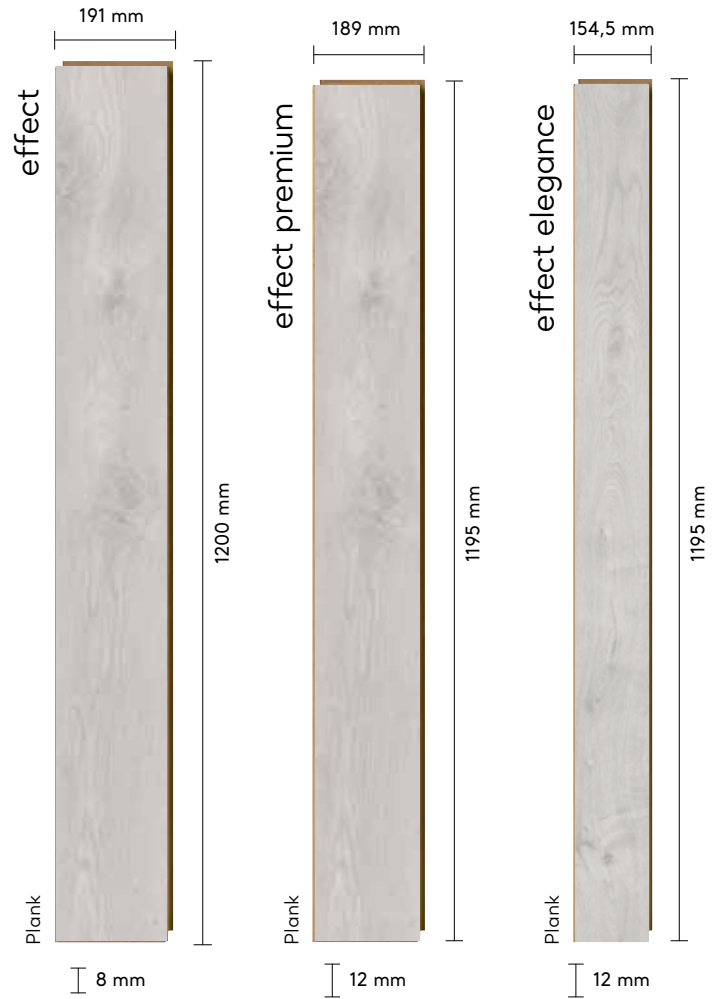

# toros

Dağların koyu toprak zenginliğini keşfedin ve yaşam alanınızda arzuladığınız görünümü yakalayın.

*Discover the richness of dark soil tones of mountains and have the look you desire in your living space.*





alip

Dağların, kar ve bulutların  
büyüleyici atmosferi!  
Mekanınızda ferah bir  
izlenime sahip olun.

*Fascinating atmosphere of  
mountains, snow and clouds!  
Have a spacious impression  
in your space.*

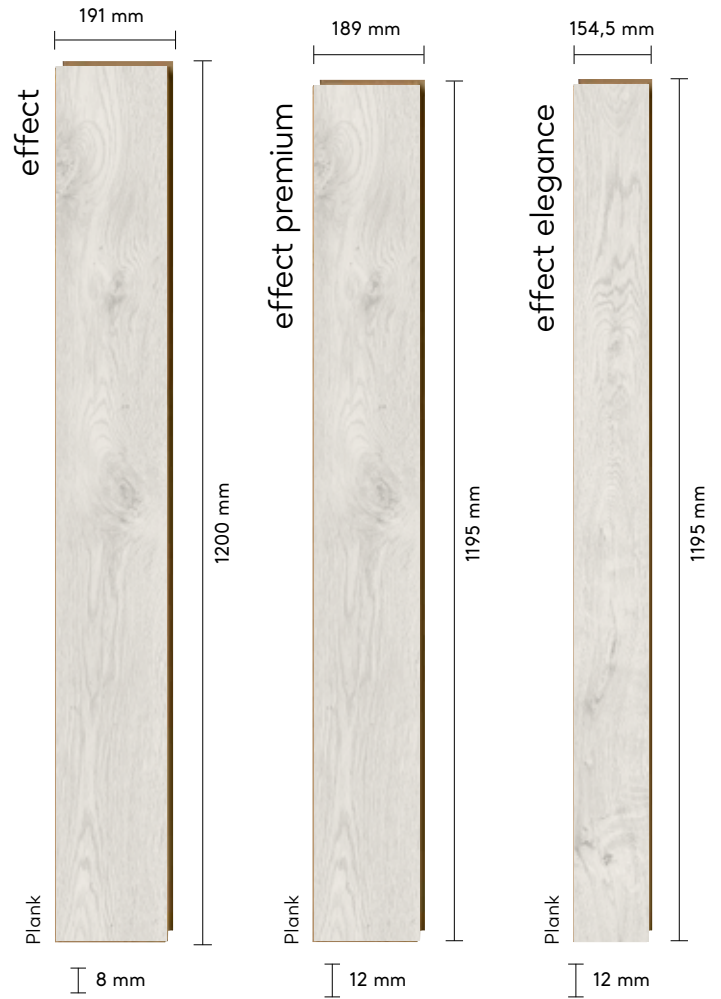

pamir

Orta Asya'nın zirvelerinden bir para!  
Sıradađların eŐsiz dekorlarıyla  
mekanınızda dođanın keyfini ıkarın.

*A piece from the peaks of Central Asia!  
Enjoy the nature vibes at your space with  
the unique decors of the mountain range.*







ural

Toprak tonların sıcaklığı  
estetikle buluştu!  
Her anınızda doğaya  
bir adım atın.

*The warmth of soil tones  
met with aesthetics!  
Take a step into the  
nature in every moment.*

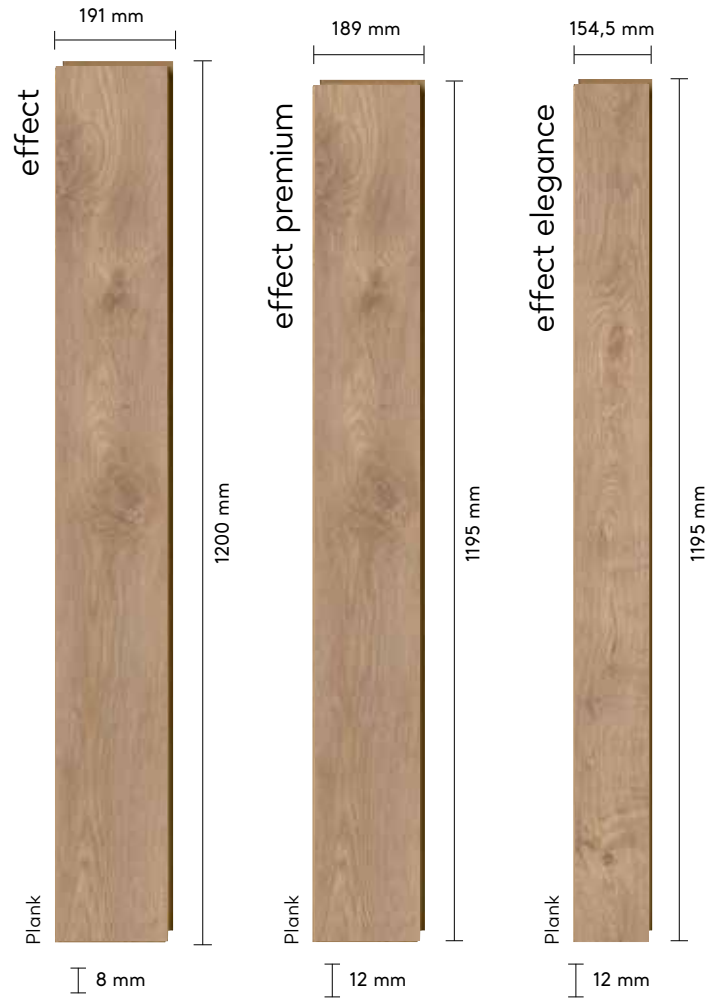



fuji

Gün batımının büyüleyici cazibesi!  
Güneşin toprakla buluşan tonlarıyla  
doğal bir görünüm elde edin.

*The charming charm of the sunset!  
Have a natural look with shades  
of the sun meets the soil.*

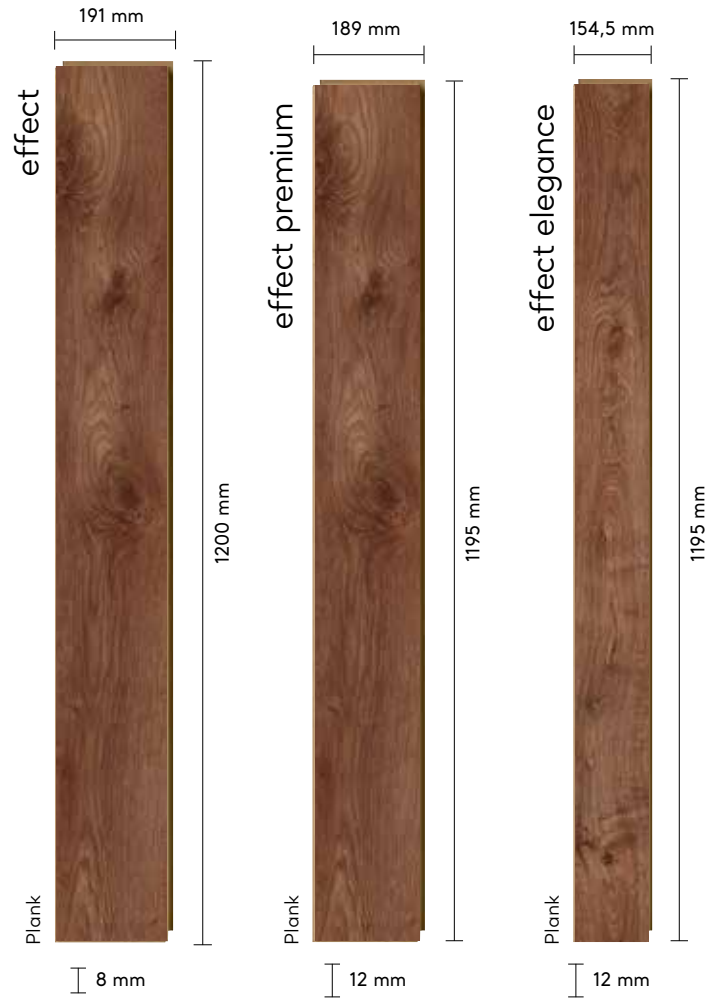

# tibet

Yaşam alanlarında mistik bir atmosfer!  
Tutkuyla şekillenen dekoruyla  
doğayı ayaklarınızın altına serin.

*A mystical atmosphere at living spaces.  
Lay the nature under your feet  
with its passionately shaped decor.*



# altay

Estetiğin doruk noktası!  
Altın, demir, bakırla  
dolu sıradağların zengin  
renklerine ayak basın.

*The climax of aesthetics!  
Take a step on to the rich  
colors of the mountain range  
filled with gold, iron and copper.*





# EFFECT / EFFECT PREMIUM / EFFECT ELEGANCE TEKNİK ÖZELLİKLER

## EFFECT / EFFECT PREMIUM / EFFECT ELEGANCE TECHNICAL SPECIFICATIONS

ÖZELLİKLER / SPECIFICATIONS	STANDART / STANDARD	SONUÇLAR / RESULTS
Elemanlar arası kalınlık farkı <i>Thickness difference between elements</i>	EN 13329	T ortalama< 0,50 mm t max-t min<0,50 mm <i>T average&lt; 0,50 mm t max-t min&lt;0,50 mm</i>
Aşınma dayanımı <i>Abrasion Resistance</i>	EN 438	Effect: Devir>4000 Cycle>4000 Effect Premium&Elegance: Devir>6000 Cycle>6000
Elemanın baş kısım gönye sapması <i>Deviation from squareness of element</i>	EN 13329	Q max< 0,2mm
Yüzey tabakasının uzunluğu <i>Length tolerance</i>	EN 13329	l<1500mm l fark<0,5mm <i>l&lt;1500mm l difference&lt;0,5mm</i>
Yüzey tabakasının genişliği <i>Width tolerance</i>	EN 13329	W ortalama fark 0,10mm w max- w min<0,20mm <i>W average difference 0,10mm w max- w min&lt;0,20mm</i>
Kılıcına dönme miktarı <i>Edgewise bending</i>	EN 13329	0,30 mm
Elemanın yüzey düzgünlüğü <i>Surface smoothness</i>	EN 13329	Fw içbükey <%0,15 fw dışbükey <%0,20 F1 içbükey <%0,50 fl dışbükey <%1,00 Fw concave <%0,15 fw convex <%0,20 F1 concave <%0,50 fl convex <%1,00
Elemanlar arası açıklık <i>Space between elements</i>	EN 13329	O ortalama<0,15mm o max 0,15mm <i>O average&lt;0,15mm o max 0,15mm</i>
Elemanlar arası yükseklik farkı <i>Height difference between elements</i>	EN 13329	H ortalama< 0,10mm H max<0,15mm <i>H average&lt; 0,10mm H max&lt;0,15mm</i>
Yüzey sağlamlığı <i>Surface soundness</i>	EN 13329	AC4 / AC5 ≥1,25 N/mm <sup>2</sup>
Çizilme mukavemeti (N) <i>Scratch resistance</i>	EN 438	>3,5
Işık haslığı <i>Light fastness</i>	EN ISO 4892 - 2:200	EN 20105 - A02'ye göre gri ölçekte ≥4 maruz kalmayan ve maruz kalan örnek parça arasındaki renk kontrastı <i>Colour contrast between unexposed and exposed sample part ≥4 of grey scale according to EN 20105 - A02</i>
Çarpma mukavemeti <i>Impact resistance</i>	EN 13329	32. sınıf için IC2 / IC2 for 32th class 33. sınıf için IC3 / IC3 for 33th class
Koltuk tekerleği etkisi <i>Determination of the effect of a castor chair</i>	EN 425	Görünümde bir değişiklik veya zarar olmayacak <i>No change or damage on appearance should occur</i>
Mobilya ayağı etkisi <i>Determination of the effect of a castor furniture</i>	EN 424	Görülebilir zarar olmamalıdır. <i>No visible damage should occur</i>
Sıcak kaplara dayanıklılık <i>Resistance to hot pots</i>	EN 13329	Sınıf 4 / Class 4
Sigara ateşine karşı dayanıklılık <i>Resistance to cigarette burns fire</i>	EN 13329	Sınıf 4 / Class 4
Su buharına karşı dayanıklılık <i>Resistance to water vapor</i>	EN 13329	Sınıf 4 / Class 4
Leke tutmaya karşı dayanıklılık <i>Stain resistance</i>	EN 13329	Sınıf 5 / Class 5
24 saat suda şişme <i>24 hours swelling in thickness</i>	EN 13329	<%18
Yoğunluk <i>Density</i>	EN 323	850-900 kg/m <sup>3</sup>
Eğilme dayanımı <i>Bending strenght</i>	EN 317	40 N/mm <sup>2</sup>
Elastikiyet modülü <i>Modulus of elasticity</i>	EN 310	3500 N/mm <sup>2</sup>
Çekme dayanımı <i>Vertical internal bond</i>	EN 319	≥1,2 N/mm <sup>2</sup>

## AŞINMA SINIFLARI/ABRASION CLASSES

EFFECT	KONUTLARDA / HOUSES			OFİSLERDE / OFFICES		
	Az / Low	Orta / Medium	Yoğun / High	Az / Low	Orta / Medium	Yoğun / High
	21	22	23	31	<b>32</b>	33
	AC1	AC2	AC3	<b>AC4</b>	AC5	
Ortalama aşınma değeri / Average abrasion value	> 900	>1500	>2000	<b>&gt;4000</b>	>6000	

## AŞINMA SINIFLARI/ABRASION CLASSES

EFFECT PREMIUM	KONUTLARDA / HOUSES			OFİSLERDE / OFFICES		
	Az / Low	Orta / Medium	Yoğun / High	Az / Low	Orta / Medium	Yoğun / High
	21	22	23	31	32	<b>33</b>
	AC1	AC2	AC3	AC4	<b>AC5</b>	
Ortalama aşınma değeri / Average abrasion value	> 900	>1500	>2000	>4000	<b>&gt;6000</b>	

## AŞINMA SINIFLARI/ABRASION CLASSES

EFFECT ELEGANCE	KONUTLARDA / HOUSES			OFİSLERDE / OFFICES		
	Az / Low	Orta / Medium	Yoğun / High	Az / Low	Orta / Medium	Yoğun / High
	21	22	23	31	32	<b>33</b>
	AC1	AC2	AC3	AC4	<b>AC5</b>	
Ortalama aşınma değeri / Average abrasion value	> 900	>1500	>2000	>4000	<b>&gt;6000</b>	

## EFFECT DEKORLAR

EFFECT DECORS



**solaro**

PRK912



**atlas**

PRK913



**elbruz**

PRK911



**logan**

PRK914



**nirvana**

PRK910



**rosso**

PRK909



**everest**

PRK903

## EFFECT SÜPÜRGELİK DEKORLAR

EFFECT SKIRTING DECORS

**gardenya**

**atlas**

**elbruz**

**logan**

**nirvana**

**rosso**

**everest**

## EFFECT DEKORLAR

EFFECT DECORS



## EFFECT SÜPÜRGELİK DEKORLAR

EFFECT SKIRTING DECORS







10 MM  
FLOORING  
PARKE

CONCEPT

NEO



En Width	Boy Length	Kalınlık Thickness	Paket kg Package kg	Paket m <sup>2</sup> Package m <sup>2</sup>
154,5 mm	1195 mm	10 mm	~13,30	~1,4770







Her zaman doğal, her zaman yenilikçi!

Concept Neo Parke Serisinin tasarımda fark yaratan dekor ve desenleriyle tanışın. Teknolojiyle buluşan trend dekorları sayesinde kusursuz ahşap dokusunu yaşam alanlarınızda hissedin.

*Always natural, always innovative!*

*Meet the decors and patterns of Concept Neo Flooring Series which make a difference in the design. Feel the perfect wood texture in your living spaces thanks to its trend decors that meets technology.*

yeni new

portello

Milano'nun sakin havasını evinize taşıyın!  
Eskimeyen tarzıyla yıllar boyu yaşam  
alanınızı aydınlatın.

*Bring the calm air of Milan into your home!  
Light up your living space for years with its  
timeless style.*



yeni new

lima

Güney Afrika'nın sıcaklığı  
evinizde yaşasın!  
Mutlu anlarınızı sıcaklığın  
modern tarzıyla doldurun.

*Let the warmth of South Africa  
live in your home!  
Fill your happy moments with  
the modern style of warmth.*





yeni new  
pero

Sıcak dekorun estetik dokunuşu!  
Mekanınızın sıcaklığına modernliği  
ve şıklığı ekleyin.

*Aesthetic touch of warm decor!  
Add modernity and elegance to the  
warmth of your space.*



scalda

Açık kahve, sıcak dekor!  
Doğal ağaç damarlarına sahip yüzeyi  
ve uzun ömürlü kullanımıyla  
mekanınızı daima yeni tutun.

*Light brown, warm decor!  
Always keep your space new  
with its natural wood veins surface  
and long-lasting use.*







moderna

İyi bir yaşam için yenilikçi bir tasarım!  
Kahverengi toprak tonlarının  
doğal dokusunu mekanınızda hissedin.

*An innovative design for a better life!  
Feel the natural texture of  
brown earth tones in your space.*

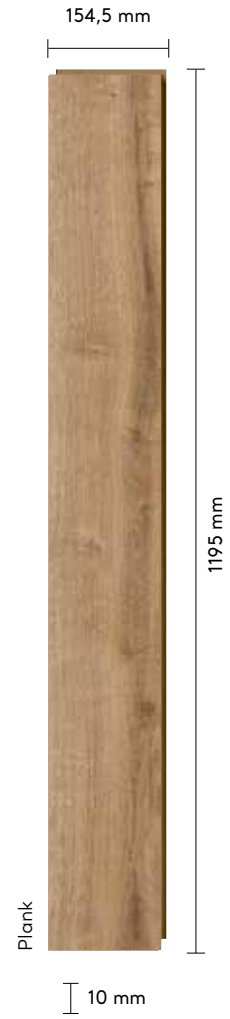

dorino

Tasarım, kültürlerden izler taşır!  
İtalya'nın sıcak havasını  
yaşam alanınızda yaşatın.

*Design has traces of cultures!  
Experience the warm weather  
of Italy in your living space.*



centro

Her zaman estetik, her zaman trend!  
Kusursuz dekoruyla uzun yıllar boyunca  
modayı ve yeniliđi yakalayın.

*Always aesthetic, always trendy!  
With its impeccable decor  
be fashionable for many years.*

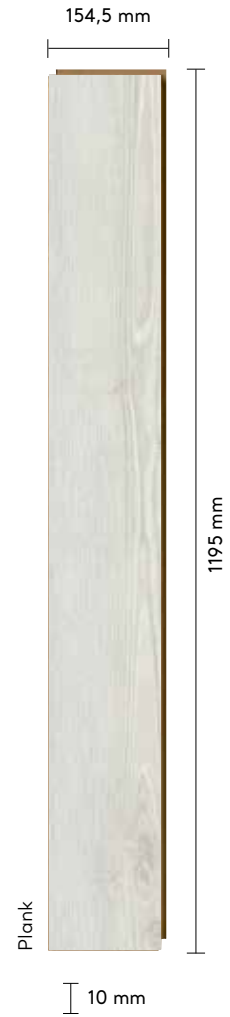



casella

Yenilikçi fikirlere yer açın!  
Duyguları yöneten renklerle  
dilediğiniz tasarımı kolayca yaratın.

*Make room for innovative ideas!  
Easily create any design  
with colors that effect emotions.*



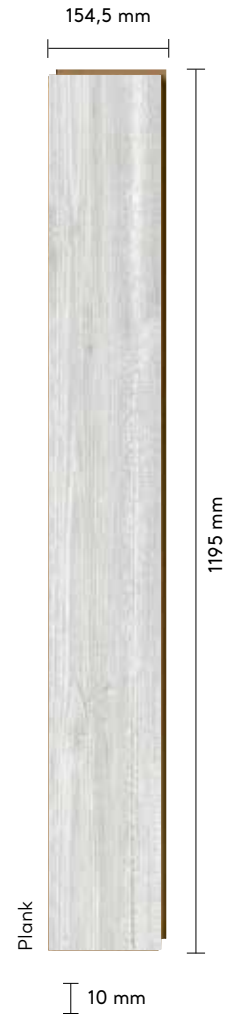

## CONCEPT NEO TEKNİK ÖZELLİKLER CONCEPT NEO TECHNICAL SPECIFICATIONS

ÖZELLİKLER / SPECIFICATIONS	STANDART / STANDARD	SONUÇLAR / RESULTS
Elemanlar arası kalınlık farkı <i>Thickness difference between elements</i>	EN 13329	T ortalama < 0,50 mm t max-t min < 0,50 mm <i>T average &lt; 0,50 mm t max-t min &lt; 0,50 mm</i>
Aşınma dayanımı (AC4) <i>Abrasion Resistance (AC4)</i>	EN 13329	Devir > 4000 <i>Cycle &gt; 4000</i>
Aşınma sınıfı <i>Abrasion Class</i>	EN 13329	32. Sınıf <i>32. Class</i>
Elemanın baş kısım gönye sapması <i>Deviation from squareness of element</i>	EN 13329	Q max < 0,2mm
Yüzey tabakasının uzunluğu <i>Length tolerance</i>	EN 13329	l < 1500mm l fark < 0,5mm <i>l &lt; 1500mm l difference &lt; 0,5mm</i>
Yüzey tabakasının genişliği <i>Width tolerance</i>	EN 13329	W ortalama fark 0,10mm w max- w min < 0,20mm <i>W average difference 0,10mm w max- w min &lt; 0,20mm</i>
Kılıcına dönme miktarı <i>Edgewise bending</i>	EN 13329	0,30 mm
Elemanın yüzey düzgünlüğü <i>Surface smoothness</i>	EN 13329	Fw içbükey < %0,15 fw dışbükey < %0,20 F1 içbükey < %0,50 fl dışbükey < %1,00 <i>Fw concave &lt; %0,15 fw convex &lt; %0,20 F1</i> <i>concave &lt; %0,50 fl convex &lt; %1,00</i>
Elemanlar arası açıklık <i>Space between elements</i>	EN 13329	O ortalama < 0,15mm o max 0,15mm <i>O avergae &lt; 0,15mm o max 0,15mm</i>
Elemanlar arası yükseklik farkı <i>Height difference between elements</i>	EN 13329	H ortalama < 0,10mm H max < 0,15mm <i>H avergae &lt; 0,10mm H max &lt; 0,15mm</i>
Yüzey sağlamlığı <i>Surface soundness</i>	EN 13329	AC4 ≥ 1,25 N/mm <sup>2</sup>
Işık haslığı <i>Light fastness</i>	EN ISO 4892 - 2:200	EN 20105 - A02'ye göre gri ölçekte ≥ 4 maruz kalmayan ve maruz kalan örnek parça arasındaki renk kontrastı <i>Colour contrast between unexposed and exposed sample part ≥ 4 of grey scale according to EN 20105 - A02</i>
Çarpma mukavemeti <i>Impact resistance</i>	EN 13329	32. sınıf için IC2 <i>IC2 for 32th class</i>
Koltuk tekerleği etkisi <i>Determination of the effect of a castor chair</i>	EN 425	Görünümde bir değişiklik veya zarar olmayacak <i>No change or damage on appearance should occur</i>
Çizilme mukavemeti (N) <i>Scratch resistance (N)</i>	EN438-2	≥ 3,5 N

ÖZELLİKLER / SPECIFICATIONS	STANDART / STANDARD	SONUÇLAR / RESULTS
Mobilya ayağı etkisi <i>Determination of the effect of a castor furniture</i>	EN 424	Görülebilir zarar olmamalıdır. <i>No visible damage should occur</i>
Sıcak kaplara dayanıklılık <i>Resistance to hot pots</i>	EN 438-2	Sınıf 4 / Class 4
Sigara ateşine karşı dayanıklılık <i>Resistance to cigarette burns fire</i>	EN 13329	Sınıf 4 / Class 4
Su buharına karşı dayanıklılık <i>Resistance to water vapor</i>	EN 438-2	Sınıf 4 / Class 4
Leke tutmaya karşı dayanıklılık <i>Stain resistance</i>	EN 438-2	Sınıf 5 / Class 5
24 saat suda şişme <i>24 hours swelling in thickness</i>	EN 13329	<%18
Yoğunluk <i>Density</i>	EN 323	850-900 Kg/m <sup>3</sup>
Eğilme dayanımı <i>Bending strenght</i>	EN 317	40 N/mm <sup>2</sup>
Elastikiyet modülü <i>Modulus of elasticity</i>	EN 310	3500 N/mm <sup>2</sup>
Çekme dayanımı <i>Vertical internal bond</i>	EN 319	≥1,20 N/mm <sup>2</sup>

## AŞINMA SINIFLARI/ABRASION CLASSES

	KONUTLARDA / HOUSES			OFİSLERDE / OFFICES		
	Az / Low	Orta / Medium	Yoğun / High	Az / Low	Orta / Medium	Yoğun / High
<b>CONCEPT NEO</b>	21	22	23	31	<b>32</b>	33
	AC1	AC2	AC3		<b>AC4</b>	AC5
Ortalama aşınma değeri / Average abrasion value	> 900	>1500	>2000		<b>&gt;4000</b>	>6000

**Renkler basılı ve dijital kataloğlarda farklılık gösterebilir. Lütfen, satış noktalarımızda bulunan gerçek ürünler ile karşılaştırınız.**

*Colors may vary in digital and printed catalogs. Please compare with the actual products in the sales points.*

## CONCEPT NEO DEKORLAR

CONCEPT NEO DECORS

Yeni  
New



Yeni  
New



Yeni  
New

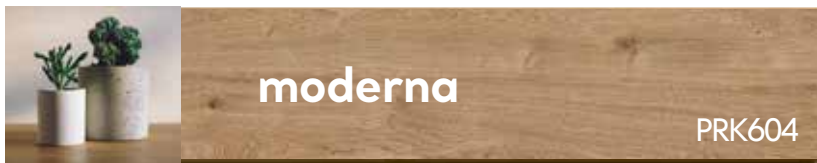
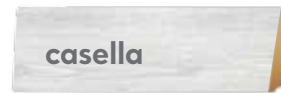
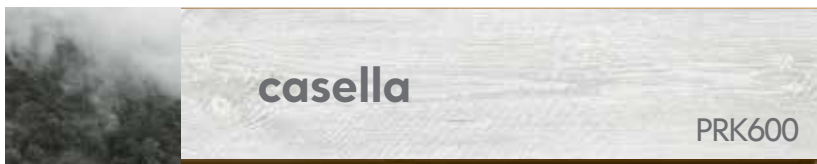
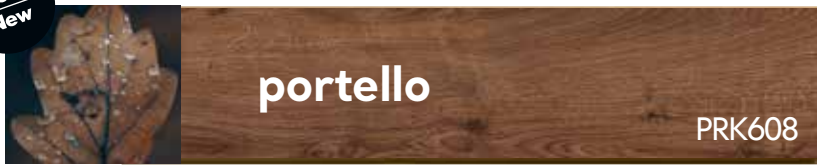

## CONCEPT NEO SÜPÜRGELİK DEKORLAR

CONCEPT NEO  
SKIRTING DECORS







8 MM  
FLOORING  
PARKE

SLIM-LARGE

ARMONIA



En Width	Boy Length	Kalınlık Thickness	Paket kg Package kg	Paket m <sup>2</sup> Package m <sup>2</sup>
246 mm	1380 mm	8 mm	~17	~2,3764
159 mm	1380 mm	8 mm	~15,70	~2,1942







Her mekana uyan eşsiz tasarımlar!

Güney sahillerinin dokusundan ilham alan  
Armonia Slim & Large Parke Serilerini keşfedin.

Dar ve geniş birlikte uygulanma seçeneği de sunan ve  
ahşabın doğallığını taşıyan yüzey dokusuyla doğayı yaşam  
alanlarınıza taşıyın.

*Unique designs that suit to every place!*

*Time to discover Armonia Flooring Series that inspired  
by the texture of south coasts. Bring nature to your living  
spaces with the surface texture that offers the option of  
being applied separately or together and carries  
the naturalness of wood.*

## minori slim

Yaşadığınız her ana estetik bir dokunuş!  
Sahil kasabasının ferahlatan doğasını ve  
mimarisini mekanınızda yaşayın.

*An aesthetic touch to any moment of life!  
Experience the refreshing nature and  
architecture of the seaside town in your space.*

## minori large



# toskana slim

Ahşabın benzersiz doğal sıcaklığı!  
Yaşam alanınızı yaz esintileriyle  
dekore edin, toprak tonlarına adım atın.

*The unique natural warmth of wood!  
Decorate your living space with  
summer breezes and step into earth tones.*

# toskana large



159 mm

toskana slim

Plank

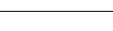

1380 mm

8 mm

246 mm

toskana large

Plank

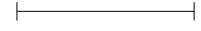

1380 mm

8 mm



## ravello slim

Ferah, sade ve şık!  
Özlemine duyduğunuz huzuru  
yaşam alanlarınıza taşıyın.

*Spacious, simple and stylish!  
Bring the peace you desire  
to the living spaces.*

## ravello large



## sorento slim

Keyifle yaşanacak anlar için!  
Yaşam alanlarınızın görünümünü  
küçük dokunuşlarla yenileyin  
ve enerjinizi yükseltin.

*For moments of joy!  
Renew the appearance of your living  
spaces with small touches and  
increase your energy.*

## sorento large





159 mm

sorento slim

Plank

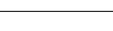

1380 mm

8 mm

246 mm

sorento large

Plank

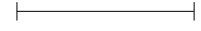

1380 mm

8 mm



## napoli slim

Özenli mekanlar, özenle tasarlanmış ürünler ister! Napoli şehrinin ferah mimarisini her adımınızda hissedin.

*Attentive spaces require carefully designed products! Feel the spacious architecture of Naples city at any step.*

## napoli large



# palermo slim

Koyu kahverengi toprak tonlar!  
İnce detaylarıyla göz dolduran dekoruyla  
mekanınızda istediğiniz konforu yakalayın.

*Dark brown earth tones!  
Have the comfort you want at your  
space with its eye-filling decor  
has fine details.*

# palermo large



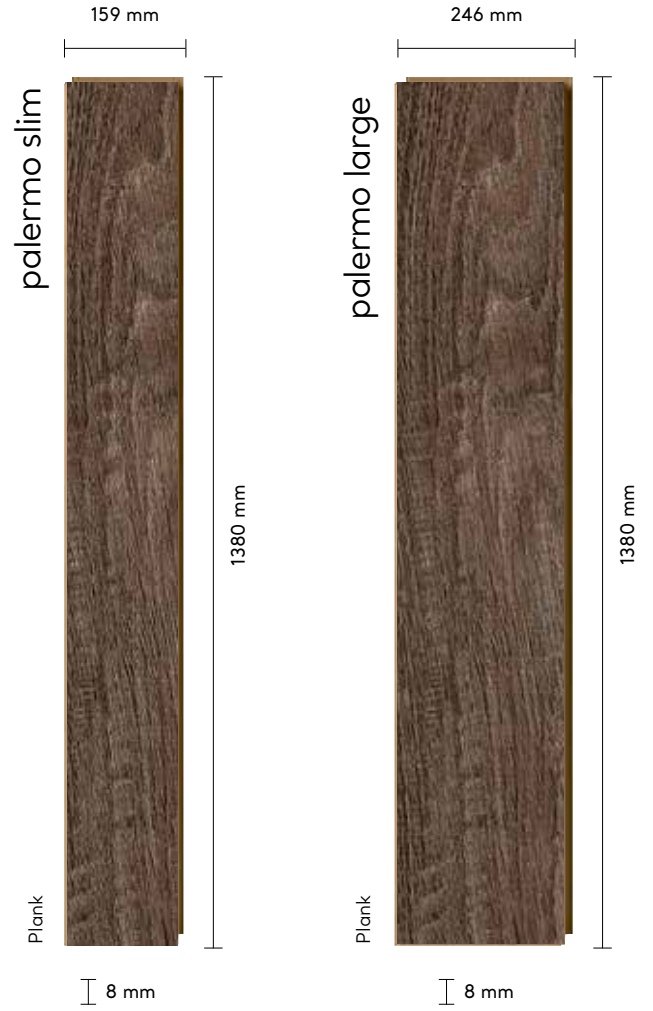

## ARMONIA SLIM/LARGE TEKNİK ÖZELLİKLER

### ARMONIA SLIM/LARGE TECHNICAL SPECIFICATIONS

ÖZELLİKLER / SPECIFICATIONS	STANDART / STANDARD	SONUÇLAR / RESULTS
Elemanlar arası kalınlık farkı <i>Thickness difference between elements</i>	EN 13329	T ortalama< 0,50 mm t max-t min<0,50 mm <i>T average&lt; 0,50 mm t max-t min&lt;0,50 mm</i>
Aşınma dayanımı <i>Abrasion Resistance</i>	EN 438	Devir>4000 <i>Cycle&gt;4000</i>
Elemanın baş kısım gönye sapması <i>Deviation from squareness of element</i>	EN 13329	Q max< 0,2mm
Yüzey tabakasının uzunluğu <i>Length tolerance</i>	EN 13329	l <1500mm l fark<0,5mm <i>l &lt;1500mm l difference&lt;0,5mm</i>
Yüzey tabakasının genişliği <i>Width tolerance</i>	EN 13329	W ortalama fark 0,10mm w max- w min<0,20mm <i>W average difference 0,10mm w max- w min&lt;0,20mm</i>
Kılıcına dönme miktarı <i>Edgewise bending</i>	EN 13329	0,30 mm
Elemanın yüzey düzgünlüğü <i>Surface smoothness</i>	EN 13329	Fw içbükey <%0,15 fw dışbükey <%0,20 F1 içbükey <%0,50 fl dışbükey <%1,00 <i>Fw concave &lt;%0,15 fw convex &lt;%0,20 F1 concave &lt;%0,50 fl convex &lt;%1,00</i>
Elemanlar arası açıklık <i>Space between elements</i>	EN 13329	O ortalama<0,15mm o max 0,15mm <i>O average&lt;0,15mm o max 0,15mm</i>
Elemanlar arası yükseklik farkı <i>Height difference between elements</i>	EN 13329	H ortalama< 0,10mm H max<0,15mm <i>H average&lt; 0,10mm H max&lt;0,15mm</i>
Yüzey sağlamlığı <i>Surface soundness</i>	EN 13329	AC4 ≥1,25 N/mm <sup>2</sup>
Çizilme mukavemeti (N) <i>Scratch resistance</i>	EN 438	>3,5
Işık haslılığı <i>Light fastness</i>	EN ISO 4892 - 2:200	EN 20105 - A02'ye göre gri ölçekte ≥4 maruz kalmayan ve maruz kalan örnek parça arasındaki renk kontrastı <i>Colour contrast between unexposed and exposed sample part ≥ 4 of grey scale according to EN 20105 - A02</i>
Çarpma mukavemeti <i>Impact resistance</i>	EN 13329	32. sınıf için IC2 <i>IC2 for 32<sup>nd</sup> class</i>
Koltuk tekerleği etkisi <i>Determination of the effect of a castor chair</i>	EN 425	Görünümde bir değişiklik veya zarar olmayacak <i>No change or damage on appearance should occur</i>
Mobilya ayağı etkisi <i>Determination of the effect of a castor furniture</i>	EN 424	Görülebilir zarar olmamalıdır. <i>No visible damage should occur</i>
Sıcak kaplara dayanıklılık <i>Resistance to hot pots</i>	EN 13329	Sınıf 4 / Class 4
Sigara ateşine karşı dayanıklılık <i>Resistance to cigarette burns fire</i>	EN 13329	Sınıf 4 / Class 4
Su buharına karşı dayanıklılık <i>Resistance to water vapor</i>	EN 13329	Sınıf 4 / Class 4
Leke tutmaya karşı dayanıklılık <i>Stain resistance</i>	EN 13329	Sınıf 5 / Class 5
24 saat suda şişme <i>24 hours swelling in thickness</i>	EN 13329	<%18
Yoğunluk <i>Density</i>	EN 323	850-900 kg/m <sup>3</sup>
Eğilme dayanımı <i>Bending strenght</i>	EN 317	40 N/mm <sup>2</sup>
Elastikiyet modülü <i>Modulus of elasticity</i>	EN 310	3500 N/mm <sup>2</sup>
Çekme dayanımı <i>Vertical internal bond</i>	EN 319	≥1,2 N/mm <sup>2</sup>

## AŞINMA SINIFLARI/ABRASION CLASSES

ARMONIA SLIM/LARGE	KONUTLARDA / HOUSES			OFİSLERDE / OFFICES		
	Az / Low	Orta / Medium	Yoğun / High	Az / Low	Orta / Medium	Yoğun / High
	21	22	23	31	<b>32</b>	33
	AC1	AC2	AC3		<b>AC4</b>	AC5
Ortalama aşınma değeri / Average abrasion value	> 900	>1500	>2000		<b>&gt;4000</b>	>6000

**Renkler basılı ve dijital kataloğlarda farklılık gösterebilir. Lütfen, satış noktalarımızda bulunan gerçek ürünler ile karşılaştırınız.**

*Colors may vary in digital and printed catalogs. Please compare with the actual products in the sales points.*

## ARMONIA SLIM/LARGE DEKORLAR

ARMONIA SLIM/LARGE  
DECORS

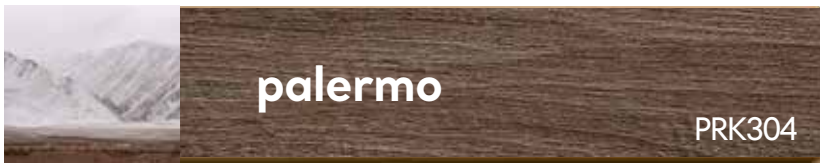
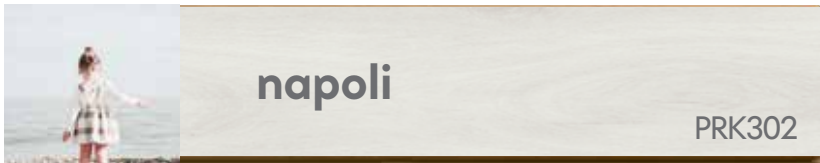

## ARMONIA SLIM/LARGE SÜPÜRGELİK DEKORLAR

ARMONIA SLIM/LARGE  
SKIRTING DECORS

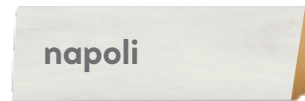
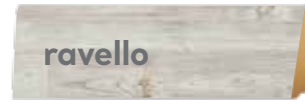





Özgün olmak, bazen tüm kalıpların dışına çıkmayı gerektirir. Armonia Slim & Large Serilerini ister ayrı ayrı, ister bir arada kullanabilirsiniz.

*Being innovative means not to follow patterns.  
So, you can use Armonia Slim & Large Series seperately or together, as a pattern.*





8 MM  
FLOORING  
PARKE

ENJ

NATURA

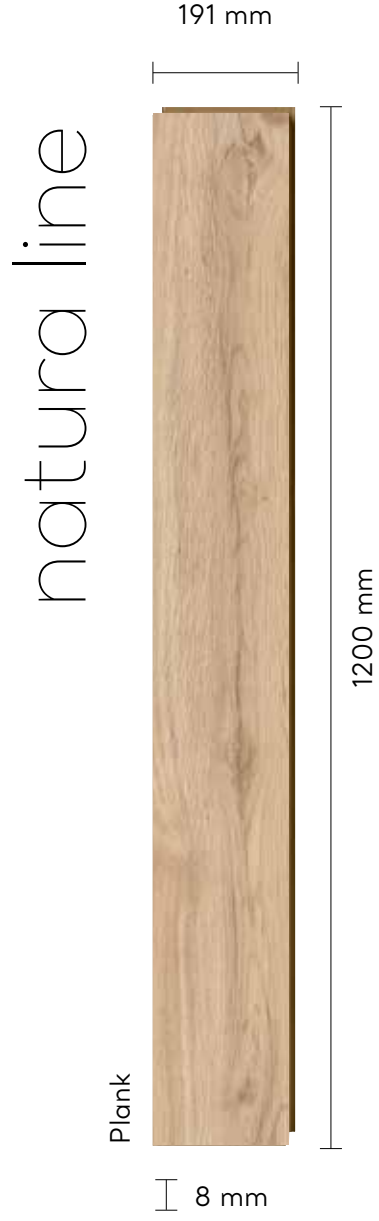

En Width	Boy Length	Kalınlık Thickness	Paket kg Package kg	Paket m <sup>2</sup> Package m <sup>2</sup>
191 mm	1200 mm	8 mm	~13,20	~1,83





Tasarım onun doğasında var!

Doğadan ilham alan tasarım ruhu, zamana meydan okuyan dayanıklı yapısı ve sıradışı tasarım. Yeni bir trend yaratan Natura Line Parke Serisi ile yaşam alanlarınıza yenilik katın.

*Design is in its nature!*

*Nature-inspired design spirit, time-defying durable construction and unusual design. Add innovation to your living spaces with the Natura Line Flooring Series, which creates a brand-new trend.*

yeni new

# amazon meşe amazon oak

Amazon ormanlarının sakinliđi!  
Amazon ormanlarının sakin ve  
huzurlu havasını mekanınıza taşıyın.

*The calmness of the Amazon jungles!  
Bring the calm and peaceful  
atmosphere of the Amazon jungles to  
your space.*



yeni new

# ren meşe ren oak

Doğanın sakinletici güzelliğinde yaşa!  
Doğanın sıcaklığı ve huzurunu yaşam  
alanında hissetmenin en modern yolu.

*Live in the calming beauty of nature!  
The most modern way to feel the warmth  
and peace of nature in your living space.*





# gala meşe

## gala oak

Sakin, huzurlu ve davetkâr!  
Kuş cenneti Gala Gölü'nün  
sarıya çalan bitkilerinin sıcak  
tonlarını mekanınıza taşıyın.

*Calm, peaceful and inviting!  
Bring warm tones of the  
yellowish plants of bird's paradise  
Gala Lake to your place.*



# salda meşe saldada oak

Doğanın eşsiz güzelliğinden bir parça!  
Türkiye'nin beyaz incisi Saldada Gölü'nün  
bembeyaz kumlarının ferahlığını  
yaşam alanlarınızda hissedin.

*A piece of nature's unique beauty!  
Feel the freshness of the snow-white sands  
of Lake Saldada, the White Pearl of Turkey,  
in your living spaces.*

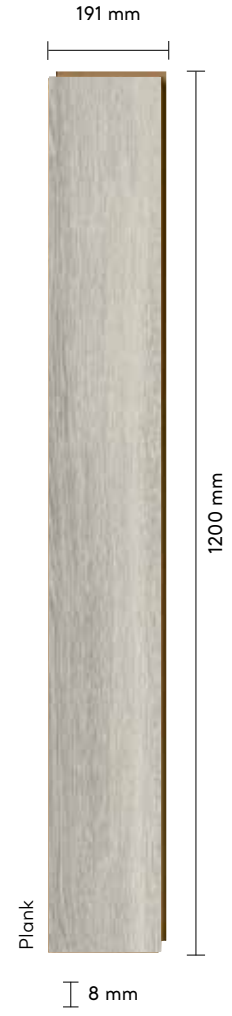

rodos

Yaşama iz bırakan doğal bir esinti!  
Akdeniz'in sıcak tonlarını ve enerjisini  
mekanınıza getirin.

*A natural breeze that leaves a mark on life!  
Bring the warm tones and energy  
of the Mediterranean to your place.*



# talya

Bahar, doğanın uyanışıdır!  
Baharın tonlarını ve doğanın  
canlanan renklerini yaşam  
alanlarınızda hissedin.

*Spring is the awakening of the nature!  
Feel the tones of spring and the  
revitalizing colors of nature in  
your living spaces.*





# İlgaz meşe İlgaz oak

Her zaman yeni, her sezon büyüleyici bir dekor! İlgaz Dağı'nın etkileyici havasını ve tonlarını mekanınızda konuk edin.

*Always new, a charming decor in every season! Enjoy the impressive air and tones of Ilgaz Mountain in your place.*



# kanyon meşe canyon oak

Doğa, dünyanın baş sanatçısıdır!  
Kanyon vadilerinin kendini yenileyen  
formuyla birleşen meşenin dayanıklılığını  
mekanınızda yaşatın.

*Nature is the chief artist of the world!  
Experience the durability of oak in your  
space that combined with the  
self-renewing form of canyon valleys.*



# meriç meric

Sınırları kaldıran benzersiz bir tasarım!  
Kültürleri bir araya getiren Meriç Nehri'nin  
toprak tonlarını mekanınıza taşıyın.

*A unique design that lifts boundaries!  
Have cool earth tones of Meriç River which  
brings cultures together at your place.*





# nil nile

Geçmişten geleceğe yenilikçi bir trend!  
Uygarlıkların doğuşuna tanık olan Nil Nehri'nin  
doğal izlerine yaşam alanınızda dokununuz.

*An innovative trend from past to future!  
Touch the natural traces of the Nile River  
in your place, where has witnessed  
the birth of civilizations.*





trend meşe  
trend oak

Ufuk açan yenilikçi dekor!  
Trendleri değiştiren doğal ve  
ılık tonuyla yaşam alanlarınızda  
farklı bir atmosfer yaratın.

*Innovative decor that opens up new horizon!  
Create a different atmosphere in your living  
spaces with its natural and warm tones  
that challenges and changes trends.*



tuna

Ahşabın teknolojiyle dansı!  
Vals dansının doğduğu toprakların ritmini  
ve Tuna Nehri'nin akışkan huzurunu  
mekanınızda hissedin.

*The dance of wood with technology!  
Feel the rhythm of the land where  
the waltz dance was born and the fluid  
peace of the Danube River in your place.*



volga

Nehirler, her akışta kendini yeniler!  
Avrupa'nın en uzun nehrinin ferahlığını  
ve iç açan rengini yaşam alanınızda keşfedin.

*Rivers refresh themselves with every flow!  
Discover the freshness and relaxing color  
of the longest river of Europe  
in your living spaces.*



selge

Antik kentlerden estetik bir para!  
Zirvelere kurulmuř Selge dađ kentinin  
mistik renklerini mekanınızda yakalayın.

*An aesthetic piece from ancient cities!  
Have the mystical colors of the  
mountain city of Selge in your space.*





## NATURA LINE PARKE TEKNİK ÖZELLİKLER

### NATURA LINE FLOORING TECHNICAL SPECIFICATIONS

ÖZELLİKLER / SPECIFICATIONS	STANDART / STANDARD	SONUÇLAR / RESULTS
Elemanlar arası kalınlık farkı <i>Thickness difference between elements</i>	EN 13329	T ortalama < 0,50 mm t max-t min < 0,50 mm <i>T average &lt; 0,50 mm t max-t min &lt; 0,50 mm</i>
Aşınma dayanımı <i>Abrasion Resistance</i>	EN 438	Devir > 4000 <i>Cycle &gt; 4000</i>
Elemanın baş kısım gönye sapması <i>Deviation from squareness of element</i>	EN 13329	Q max < 0,2mm
Yüzey tabakasının uzunluğu <i>Length tolerance</i>	EN 13329	l < 1500mm l fark < 0,5mm <i>l &lt; 1500mm l difference &lt; 0,5mm</i>
Yüzey tabakasının genişliği <i>Width tolerance</i>	EN 13329	W ortalama fark 0,10mm w max- w min < 0,20mm <i>W average difference 0,10mm w max- w min &lt; 0,20mm</i>
Kılıcına dönme miktarı <i>Edgewise bending</i>	EN 13329	0,30 mm
Elemanın yüzey düzgünlüğü <i>Surface smoothness</i>	EN 13329	Fw içbükey < %0,15 fw dışbükey < %0,20 F1 içbükey < %0,50 fl dışbükey < %1,00 <i>Fw concave &lt; %0,15 fw convex &lt; %0,20 F1 concave &lt; %0,50 fl convex &lt; %1,00</i>
Elemanlar arası açıklık <i>Space between elements</i>	EN 13329	O ortalama < 0,15mm o max 0,15mm <i>O average &lt; 0,15mm o max 0,15mm</i>
Elemanlar arası yükseklik farkı <i>Height difference between elements</i>	EN 13329	H ortalama < 0,10mm H max < 0,15mm <i>H average &lt; 0,10mm H max &lt; 0,15mm</i>
Yüzey sağlamlığı <i>Surface soundness</i>	EN 13329	AC4 ≥ 1,25 N/mm <sup>2</sup>
Çizilme mukavemeti (N) <i>Scratch resistance</i>	EN 438	> 3,5
Işık haslılığı <i>Light fastness</i>	EN ISO 4892 - 2:200	EN 20105 - A02'ye göre gri ölçekte ≥ 4 maruz kalmayan ve maruz kalan örnek parça arasındaki renk kontrastı <i>Colour contrast between unexposed and exposed sample part ≥ 4 of grey scale according to EN 20105 - A02</i>
Çarpma mukavemeti <i>Impact resistance</i>	EN 13329	32. sınıf için IC2 <i>IC2 for 32<sup>th</sup> class</i>
Koltuk tekerleği etkisi <i>Determination of the effect of a castor chair</i>	EN 425	Görünümde bir değişiklik veya zarar olmayacak <i>No change or damage on appearance should occur</i>
Mobilya ayağı etkisi <i>Determination of the effect of a castor furniture</i>	EN 424	Görülebilir zarar olmamalıdır. <i>No visible damage should occur</i>
Sıcak kaplara dayanıklılık <i>Resistance to hot pots</i>	EN 13329	Sınıf 4 / Class 4
Sigara ateşine karşı dayanıklılık <i>Resistance to cigarette burns fire</i>	EN 13329	Sınıf 4 / Class 4
Su buharına karşı dayanıklılık <i>Resistance to water vapor</i>	EN 13329	Sınıf 4 / Class 4
Leke tutmaya karşı dayanıklılık <i>Stain resistance</i>	EN 13329	Sınıf 5 / Class 5
24 saat suda şişme <i>24 hours swelling in thickness</i>	EN 13329	< %18
Yoğunluk <i>Density</i>	EN 323	850-900 kg/m <sup>3</sup>
Eğilme dayanımı <i>Bending strenght</i>	EN 317	40 N/mm <sup>2</sup>
Elastikiyet modülü <i>Modulus of elasticity</i>	EN 310	3500 N/mm <sup>2</sup>
Çekme dayanımı <i>Vertical internal bond</i>	EN 319	≥ 1,2 N/mm <sup>2</sup>

## AŞINMA SINIFLARI/ABRASION CLASSES

NATURA LINE	KONUTLARDA / HOUSES			OFİSLERDE / OFFICES		
	Az / Low	Orta / Medium	Yoğun / High	Az / Low	Orta / Medium	Yoğun / High
	21	22	23	31	<b>32</b>	33
	AC1	AC2	AC3		<b>AC4</b>	AC5
Ortalama aşınma değeri / Average abrasion value	> 900	>1500	>2000		<b>&gt;4000</b>	>6000

**Renkler basılı ve dijital kataloğlarda farklılık gösterebilir. Lütfen, satış noktalarımızda bulunan gerçek ürünler ile karşılaştırınız.**

*Colors may vary in digital and printed catalogs. Please compare with the actual products in the sales points.*

## NATURA LINE DEKORLAR

NATURA LINE DECORS

Yeni  
New

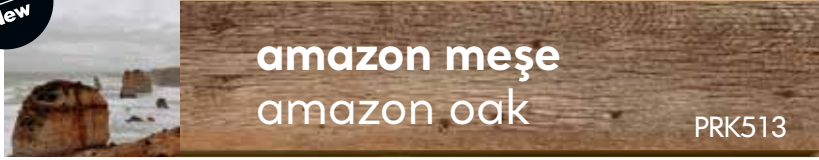

Yeni  
New

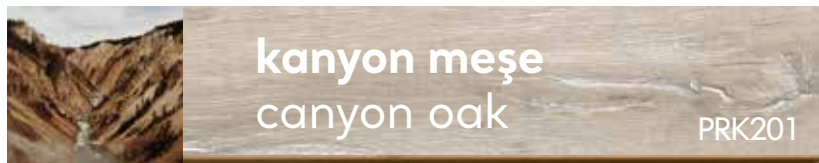
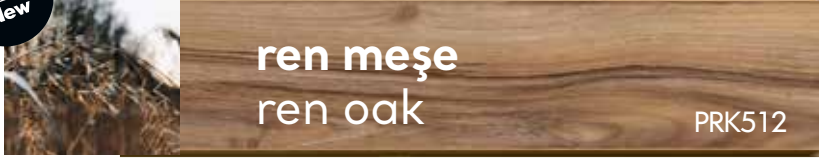

## NATURA LINE SÜPÜRGELİK DEKORLAR

NATURA LINE SKIRTING  
DECORS



## NATURA LINE DEKORLAR

NATURA LINE DECORS



## NATURA LINE SÜPÜRGELİK DEKORLAR

NATURA LINE SKIRTING  
DECORS

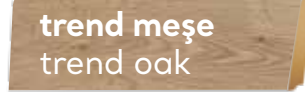
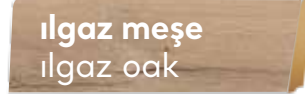



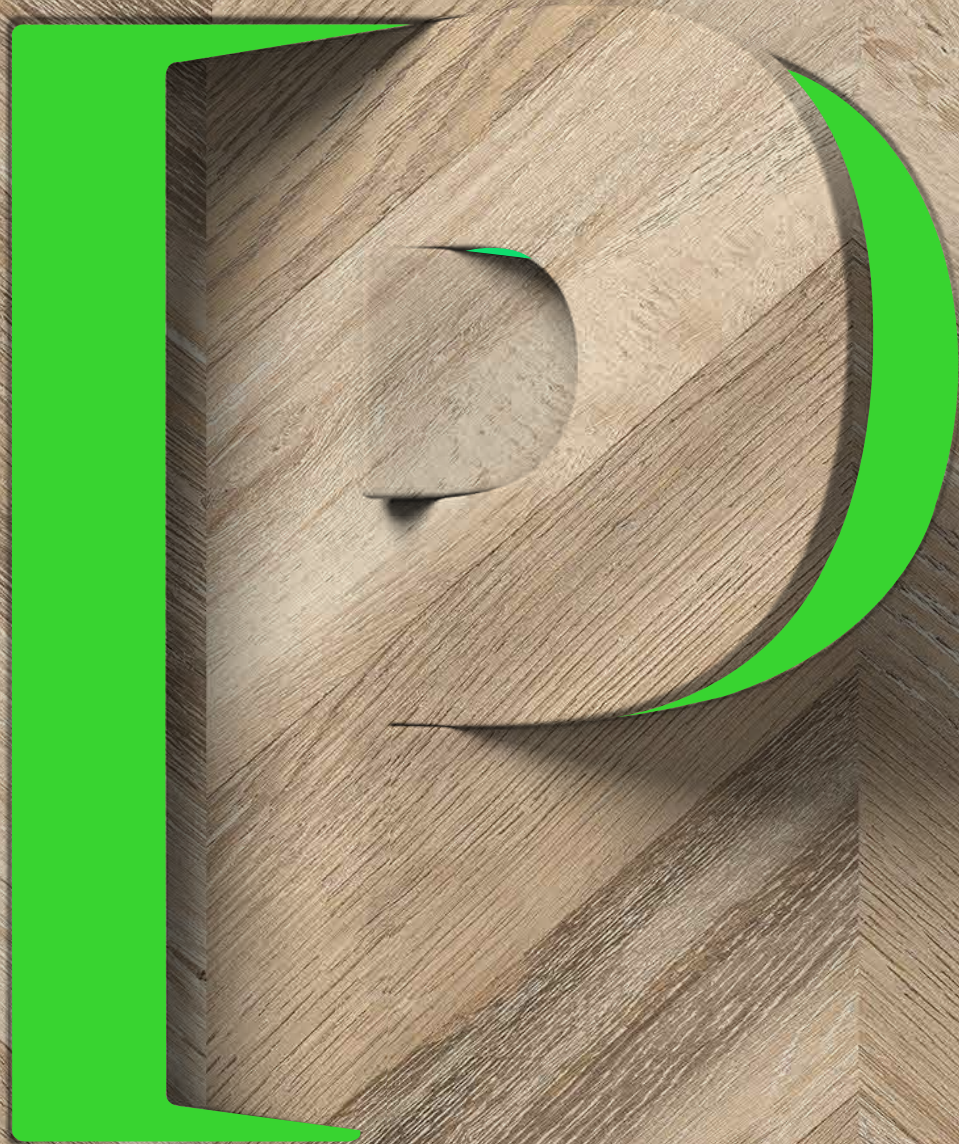

8 MM  
FLOORING  
PARKE

**PRUVA**



En Width	Boy Length	Kalınlık Thickness	Paket kg Package kg	Paket m <sup>2</sup> Package m <sup>2</sup>
188 mm	1200 mm	8 mm	~12,90	~1,8048







Zengin tonların büyüleyici etkisi!

Chevron desene yeni bir yorum sunan Pruva, yaşam alanlarında çok doğal ve bir o kadar da canlı bir görünüm elde etmenizi sağlar.

*Fascinating effect of rich tones!*

*Pruva that offers a new interpretation of chevron pattern design. It allows you to have a very natural and vibrant look in your living spaces.*

yeni new

parima

İçinizi açan modernlik!  
Deniz esintilerinin ferahlatıcı etkisini evinizde hissedin.

*Modernity that opens your heart!  
Feel the refreshing effect of sea breezes at home.*

# Pruva



yeni new  
cenova

Evinizi, canlılık ve ferahlık katan dekorun büyüü ile aydınlatın.

*Light up your home with the magic of decor that adds vitality and comfort.*

# Pruva





yeni new

alesta

Evinizde modernliğe yelken açın!  
Sakin bir dekorla huzuru  
yakalayın.

*Sail to modernity in your home!  
Find peace with a calm decor.*

# Pruya

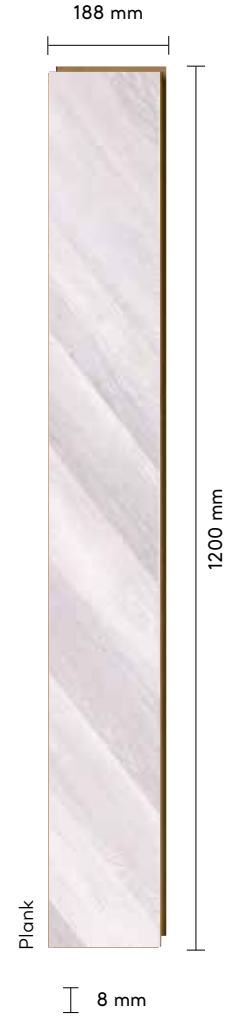

yeni new

# patalya

Şıklığın derinliğindeki dekor!  
Değerini yıllar boyu koruyan eşsiz  
tasarımla evine deniz havası kat.

*Decor in the depth of elegance!  
Add sea air to your home with a  
unique design that preserves its  
value for years.*



# Pruya



# likya

Akdeniz'in eşsiz doğası ve tarihinden esinlenen Likya ile doğallığı mekanınızda yaşayın.

*Live the naturalness at your place with Likya which inspired by the unique nature and history of the Mediterranean.*

# Pruya



## PRUVA TEKNİK ÖZELLİKLER PRUVA TECHNICAL SPECIFICATIONS

ÖZELLİKLER / SPECIFICATIONS	STANDART / STANDARD	SONUÇLAR / RESULTS
Elemanlar arası kalınlık farkı <i>Thickness difference between elements</i>	EN 13329	T ortalama < 0,50 mm t max-t min < 0,50 mm T average < 0,50 mm t max-t min < 0,50 mm
Aşınma dayanımı <i>Abrasion Resistance</i>	EN 438	Devir > 4000 Cycle > 4000
Elemanın baş kısmı gönye sapması <i>Deviation from squareness of element</i>	EN 13329	Q max < 0,2 mm
Yüzey tabakasının uzunluğu <i>Length tolerance</i>	EN 13329	l < 1500 mm l fark < 0,5 mm l < 1500 mm l difference < 0,5 mm
Yüzey tabakasının genişliği <i>Width tolerance</i>	EN 13329	W ortalama fark 0,10 mm w max- w min < 0,20 mm W average difference 0,10 mm w max- w min < 0,20 mm
Kılıcına dönme miktarı <i>Edgewise bending</i>	EN 13329	0,30 mm
Elemanın yüzey düzgünlüğü <i>Surface smoothness</i>	EN 13329	Fw içbükey < %0,15 fw dışbükey < %0,20 F1 içbükey < %0,50 fl dışbükey < %1,00 Fw concave < %0,15 fw convex < %0,20 F1 concave < %0,50 fl convex < %1,00
Elemanlar arası açıklık <i>Space between elements</i>	EN 13329	O ortalama < 0,15 mm o max 0,15 mm O average < 0,15 mm o max 0,15 mm
Elemanlar arası yükseklik farkı <i>Height difference between elements</i>	EN 13329	H ortalama < 0,10 mm H max < 0,15 mm H average < 0,10 mm H max < 0,15 mm
Yüzey sağlamlığı <i>Surface soundness</i>	EN 13329	AC4 ≥ 1,25 N/mm <sup>2</sup>
Çizilme mukavemeti (N) <i>Scratch resistance</i>	EN 438	> 3,5
Işık haslılığı <i>Light fastness</i>	EN ISO 4892 - 2:200	EN 20105 - A02'ye göre gri ölçekte ≥ 4 maruz kalmayan ve maruz kalan örnek parça arasındaki renk kontrastı Colour contrast between unexposed and exposed sample part ≥ 4 of grey scale according to EN 20105 - A02
Çarpma mukavemeti <i>Impact resistance</i>	EN 13329	32. sınıf için IC2 IC2 for 32 <sup>nd</sup> class
Koltuk tekerleği etkisi <i>Determination of the effect of a castor chair</i>	EN 425	Görünümde bir değişiklik veya zarar olmayacak No change or damage on appearance should occur
Mobilya ayağı etkisi <i>Determination of the effect of a castor furniture</i>	EN 424	Görülebilir zarar olmamalıdır. No visible damage should occur
Sıcak kaplara dayanıklılık <i>Resistance to hot pots</i>	EN 13329	Sınıf 4 / Class 4
Sigara ateşine karşı dayanıklılık <i>Resistance to cigarette burns fire</i>	EN 13329	Sınıf 4 / Class 4
Su buharına karşı dayanıklılık <i>Resistance to water vapor</i>	EN 13329	Sınıf 4 / Class 4
Leke tutmaya karşı dayanıklılık <i>Stain resistance</i>	EN 13329	Sınıf 5 / Class 5
24 saat suda şişme <i>24 hours swelling in thickness</i>	EN 13329	< %18
Yoğunluk <i>Density</i>	EN 323	850-900 kg/m <sup>3</sup>
Eğilme dayanımı <i>Bending strenght</i>	EN 317	40 N/mm <sup>2</sup>
Elastikiyet modülü <i>Modulus of elasticity</i>	EN 310	3500 N/mm <sup>2</sup>
Çekme dayanımı <i>Vertical internal bond</i>	EN 319	≥ 1,2 N/mm <sup>2</sup>

## AŞINMA SINIFLARI/ABRASION CLASSES

PRUVA	KONUTLARDA / HOUSES			OFİSLERDE / OFFICES		
	Az / Low	Orta / Medium	Yoğun / High	Az / Low	Orta / Medium	Yoğun / High
	21	22	23	31	<b>32</b>	33
	AC1	AC2	AC3	<b>AC4</b>	AC5	
Ortalama aşınma değeri / Average abrasion value	> 900	>1500	>2000	<b>&gt;4000</b>	>6000	

**Renkler basılı ve dijital kataloğlarda farklılık gösterebilir. Lütfen, satış noktalarımızda bulunan gerçek ürünler ile karşılaştırınız.**

*Colors may vary in digital and printed catalogs. Please compare with the actual products in the sales points.*

## PRUVA DEKORLAR

PRUVA DECORS

Yeni  
New



Yeni  
New



Yeni  
New



Yeni  
New



## PRUVA SÜPÜRGELİK DEKORLAR

PRUVA SKIRTING  
DECORS







8 MM  
FLOORING  
PARKE

**NATURA**

**SELECT**





En Width	Boy Length	Kalınlık Thickness	Paket kg Package kg	Paket m <sup>2</sup> Package m <sup>2</sup>
191 mm	1200 mm	8 mm	~13,20	~1,8336



Yeni bir yaşam, yeni bir doğa.

Doğanın büyüğü dünyasından özenle seçilen  
Natura Select Parke Serisi ile yaşam alanlarınıza  
yenilik katın.

*A new life, a new nature.*

*Add innovation to your living spaces with the  
Natura Select Flooring Series which selected  
carefully from the magical side of nature.*



yenı new  
sia meşe  
sia oak

Doğanın eşsiz güzelliği ve sakinliğin özenli dokusu evinize doğal bir hava katsın.

*Let the unique beauty of nature and the elaborate texture of calmness add a natural atmosphere to your home.*



yeni new  
 patricia

İtalya'nın doğal güzelliği  
evinle buluşsun!  
Doğadan alınan eşsiz ilhamla  
üretilen dekorla yaşamın  
huzur dolsun.

*Let the natural beauty of  
Italy meet with your home!  
Let your life be full of peace  
with the decor produced with  
the unique inspiration  
of nature.*



# portofino

Akdeniz'in cennet kıyılarından bir parça!  
Güneşin değdiği sıcak toprak tonlarını mekanınıza taşıyın.

*A piece of the heavenly shores of the Mediterranean!  
Bring warm earth tones that touch the sun to your space.*





porto

Asil liman kentlerinin iç açan ferahlığı!  
Doğal damarlara sahip gri tonlarla  
mekanınızın havasını değiştirin.

*Hearth-warming refreshment  
of noble port cities!  
Change the mood of your space with  
shades of gray that has natural veins.*

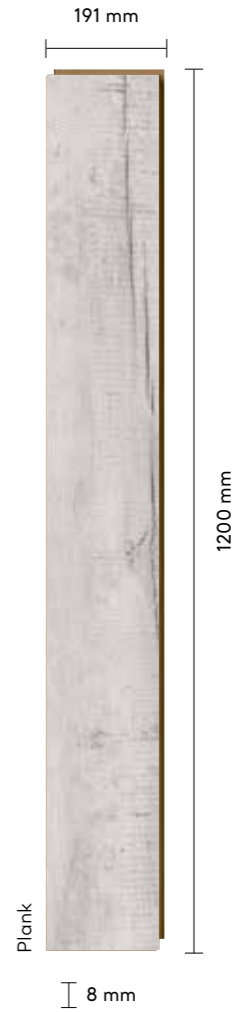



morella

Geçmişin izlerini taşıyan eşsiz bir miras!  
Morella Kalesi'nin güçlü surlarının dokusunu  
yaşam alanlarınıza getirin.

*A unique legacy that has traces of the past!  
Bring the Morella Castle's powerful  
fortifications textures to your living spaces.*

Natura  
SELECT





# lugano

Yaz tonlarının sıcak esintileri!  
Lugano Gölü'ne komşu evlerin  
tonlarını mekanınızda hissedin.

*Warm breezes of summer!  
Feel the shades of houses  
adjacent to Lake Lugano  
at your living spaces.*

**Natura**  
SELECT





bergama  
pergamon

Güneşin beslediği büyük abidelerden bir iz! Yaz şehirlerinin esintilerini mekanlarınıza taşıyarak ayaklarınıza serin.

*A trace from huge monuments that lay under the sun! Carry the breezes of summer cities to your places and lay under your feet.*







patara

Antik kentlerden doğan güzellik!  
Beyaza çalan kumların ferahlatan  
esintilerini mekanınızda yakalayın.

*Beauty that born from ancient cities!  
Have the refreshing breezes of  
white sands in your living spaces.*



# antalya çam antalya pine

Doğallık trendine yeni bir soluk!  
Çamın keskin çizgilerini ve  
Antalya'nın doğal güzelliğini  
mekanınıza taşıyın.

*A new breathtaking natural decor.  
Bring the sharp lines of pine and  
the natural beauty of Antalya city  
to your place.*

Natura  
SELECT





şiraz meşe  
shiraz oak

Sanatsal bir zenginlik!  
Pers İmparatorluğu'nun kültür başkenti Şiraz kentinin izlerini yaşam alanlarınıza konuk edin.

*An artistic wealth!  
Welcome the traces and beauty of the city of Shiraz, the cultural capital of the Persian Empire, to your living spaces.*





# kanyon meşe canyon oak

Yıllara meydan okuyan güç!  
Toprağın yalın ve eşsiz renk  
tonlarıyla meşenin kıvrımlı  
formunu mekanınızda yakalayın.

*A power that defies years!  
Have the curved atmosphere  
of oak in your space with the  
lean and unique hues of the soil.*

Natura  
SELECT





olimpus meşe  
olympus oak

Günümüze ulaşan efsane!  
Toros Dağları'nın muhteşem  
tonlarıyla mekanınıza  
canlilik ve sıcaklık getirin.

*A legend that has reached today!  
Bring vitality and warmth to  
your place with the gorgeous  
patterns Taurus Mountains.*





natura meşe  
natura oak

Sıcak, samimi ve cömert bir doku!  
Doğanın cömertliğini keşfedin ve  
yaşam alanlarınıza taşıyın.

*Warm, friendly and generous texture!  
Discover the generosity of nature  
and bring it into your living spaces.*



pasifik çam  
pacific pine

Pasifik Okyanusu'nun suladığı topraklardan eşsiz bir parça! Benzersiz dekoru ve özgün çizgileriyle yaşam alanlarınıza taze bir enerji katın.

*A unique piece of land irrigated by the Pacific Ocean!  
Add fresh energy to your living spaces with its authentic decor and original lines.*

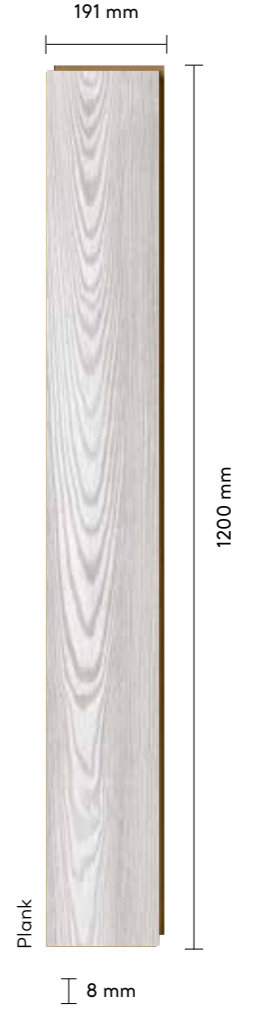

# gri meşe grey oak

Daima genç, daima yeni!  
Ölümsüzlüğün ve gençliğin  
sembolü olan meşe ağacının  
kendini yenileyen formunu  
mekanınızda hissedin.

*Always young, always new!  
Feel the renewed form of  
the oak tree, a symbol  
of immortality and youth,  
in your space.*

Natura  
SELECT







alara meşe  
alara oak

Zaman geçse de güzellik her zaman baki!  
Alara Kalesi'nin surlarını andıran deseni ve rengiyle yaşam alanlarınızda yeniliği yaşayın.

*Beauty is always remain over, although time passes!  
Experience innovation in your living spaces with pattern and color resembling the walls of Alara Castle.*



silyon meşe  
silyon oak

Antik Yunan'dan günümüze bir miras!  
Meşe ağacının beyaz ve kahve tonlarının  
harmanıyla mekanınızı yenileyin.

*A legacy from Ancient Greece!  
Renew your space with blend of  
oak white and brown tones.*





beyaz meşe  
white oak

Değerini kaybetmeyen bir ikon!  
Beyazın asiliği ve meşenin doğallığıyla  
mekanınızın atmosferini değiştirin.

*An icon that isn't lose its value!  
Change the atmosphere of your place  
with the rebelliousness of white  
and the naturalness of oak.*

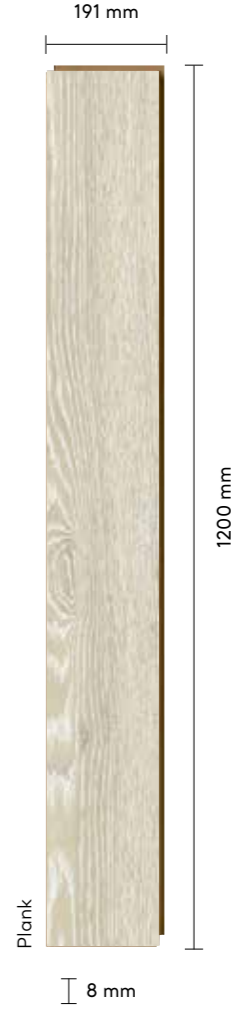

kemer çam  
kemer pine

Antalya'nın cennet köşesinden doğal ve estetik bir dokunuş! Kemer'in doğasının izleriyle mekanınıza yeni bir esinti katın.

*A natural touch from the paradise corner of Antalya! Bring a fresh breeze to your living spaces with traces of Kemer's unique nature.*



niksar ceviz  
niksar walnut

Bereketin ve efsanelerin simgesi!  
Asalet ve seçkinliğin sembolü  
ceviz ağacının sağlam dokusunu hissedin.

*A symbol of fertility and legends!  
Feel the solid texture of walnut tree,  
a symbol of nobility and elitism.*



## NATURA SELECT TEKNİK ÖZELLİKLER NATURA SELECT TECHNICAL SPECIFICATIONS

ÖZELLİKLER / SPECIFICATIONS	STANDART / STANDARD	SONUÇLAR / RESULTS
Elemanlar arası kalınlık farkı <i>Thickness difference between elements</i>	EN 13329	T ortalama< 0,50 mm t max-t min<0,50 mm <i>T average&lt; 0,50 mm t max-t min&lt;0,50 mm</i>
Aşınma dayanımı <i>Abrasion Resistance</i>	EN 438	Devir>4000 <i>Cycle&gt;4000</i>
Elemanın baş kısım gönye sapması <i>Deviation from squareness of element</i>	EN 13329	Q max< 0,2mm
Yüzey tabakasının uzunluğu <i>Length tolerance</i>	EN 13329	l<1500mm l fark<0,5mm <i>l&lt;1500mm l difference&lt;0,5mm</i>
Yüzey tabakasının genişliği <i>Width tolerance</i>	EN 13329	W ortalama fark 0,10mm w max- w min<0,20mm <i>W average difference 0,10mm w max- w min&lt;0,20mm</i>
Kılıcına dönme miktarı <i>Edgewise bending</i>	EN 13329	0,30 mm
Elemanın yüzey düzgünlüğü <i>Surface smoothness</i>	EN 13329	Fw içbükey <%0,15 fw dışbükey <%0,20 F1 içbükey <%0,50 fl dışbükey <%1,00 <i>Fw concave &lt;%0,15 fw convex &lt;%0,20 F1 concave &lt;%0,50 fl convex &lt;%1,00</i>
Elemanlar arası açıklık <i>Space between elements</i>	EN 13329	O ortalama<0,15mm o max 0,15mm <i>O average&lt;0,15mm o max 0,15mm</i>
Elemanlar arası yükseklik farkı <i>Height difference between elements</i>	EN 13329	H ortalama< 0,10mm H max<0,15mm <i>H average&lt; 0,10mm H max&lt;0,15mm</i>
Yüzey sağlamlığı <i>Surface soundness</i>	EN 13329	AC4 ≥1,25 N/mm <sup>2</sup>
Çizilme mukavemeti (N) <i>Scratch resistance</i>	EN 438	>3,5
Işık haslılığı <i>Light fastness</i>	EN ISO 4892 - 2:200	EN 20105 - A02'ye göre gri ölçekte ≥4 maruz kalmayan ve maruz kalan örnek parça arasındaki renk kontrastı <i>Colour contrast between unexposed and exposed sample part ≥4 of grey scale according to EN 20105 - A02</i>
Çarpma mukavemeti <i>Impact resistance</i>	EN 13329	32. sınıf için IC2 <i>IC2 for 32<sup>nd</sup> class</i>
Koltuk tekerleği etkisi <i>Determination of the effect of a castor chair</i>	EN 425	Görünümde bir değişiklik veya zarar olmayacak <i>No change or damage on appearance should occur</i>
Mobilya ayağı etkisi <i>Determination of the effect of a castor furniture</i>	EN 424	Görülebilir zarar olmamalıdır. <i>No visible damage should occur</i>
Sıcak kaplara dayanıklılık <i>Resistance to hot pots</i>	EN 13329	Sınıf 4 / Class 4
Sigara ateşine karşı dayanıklılık <i>Resistance to cigarette burns fire</i>	EN 13329	Sınıf 4 / Class 4
Su buharına karşı dayanıklılık <i>Resistance to water vapor</i>	EN 13329	Sınıf 4 / Class 4
Leke tutmaya karşı dayanıklılık <i>Stain resistance</i>	EN 13329	Sınıf 5 / Class 5
24 saat suda şişme <i>24 hours swelling in thickness</i>	EN 13329	<%18
Yoğunluk <i>Density</i>	EN 323	850-900 kg/m <sup>3</sup>
Eğilme dayanımı <i>Bending strenght</i>	EN 317	40 N/mm <sup>2</sup>
Elastikiyet modülü <i>Modulus of elasticity</i>	EN 310	3500 N/mm <sup>2</sup>
Çekme dayanımı <i>Vertical internal bond</i>	EN 319	≥1,2 N/mm <sup>2</sup>

## AŞINMA SINIFLARI/ABRASION CLASSES

NATURA SELECT	KONUTLARDA / HOUSES			OFİSLERDE / OFFICES		
	Az / Low	Orta / Medium	Yoğun / High	Az / Low	Orta / Medium	Yoğun / High
	21	22	23	31	32	33
	AC1	AC2	AC3	AC4	AC5	
Ortalama aşınma değeri / Average abrasion value	> 900	>1500	>2000	>4000	>6000	

Renkler basılı ve dijital kataloglarda farklılık gösterebilir. Lütfen, satış noktalarımızda bulunan gerçek ürünler ile karşılaştırınız.

Colors may vary in digital and printed catalogs. Please compare with the actual products in the sales points.

**NATURA SELECT**  
**DEKORLAR**  
NATURA SELECT DECORS

Yeni  
New

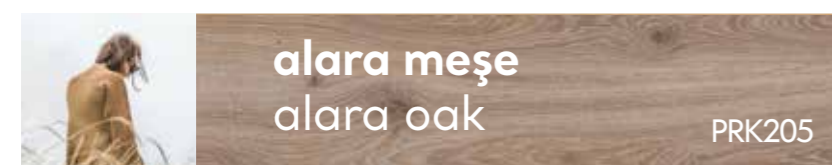
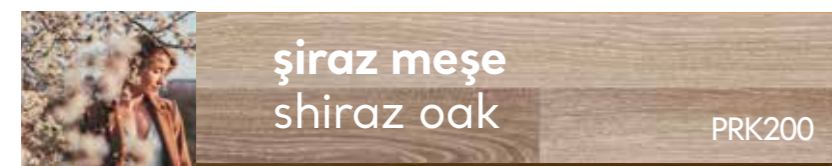
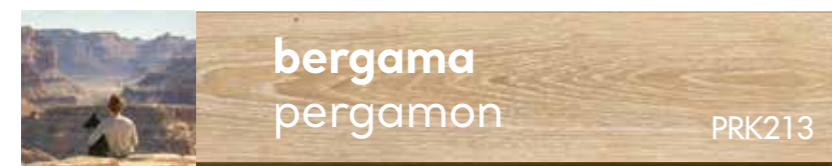
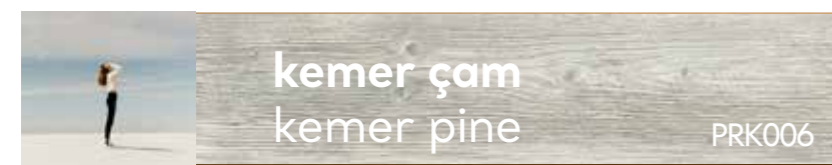
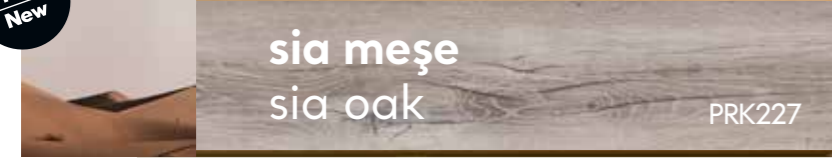

**NATURA SELECT**  
**SÜPÜRGELİK DEKORLAR**  
NATURA SELECT SKIRTING  
DECORS

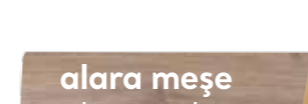
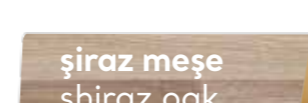
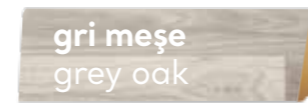

**NATURA SELECT**  
**DEKORLAR**  
NATURA SELECT DECORS

Yeni  
New

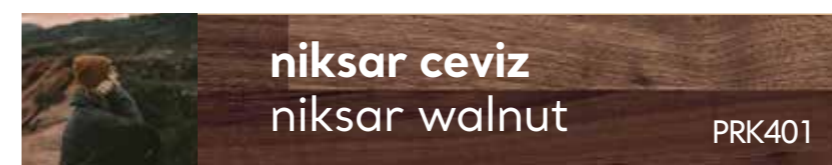
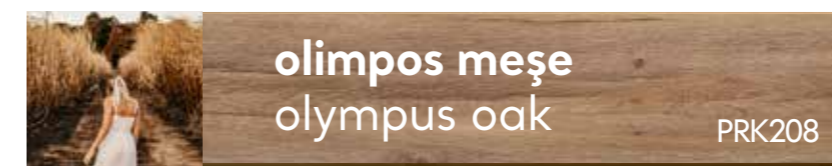
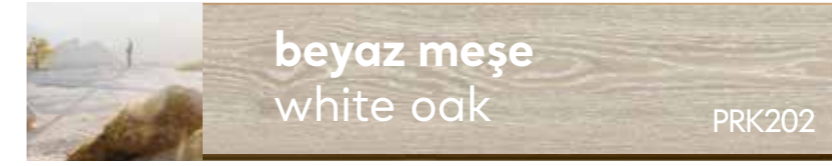

**NATURA SELECT**  
**SÜPÜRGELİK DEKORLAR**  
NATURA SELECT SKIRTING  
DECORS

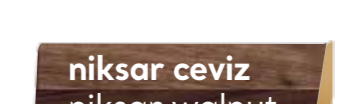
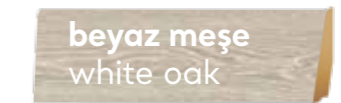
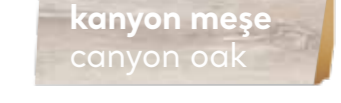
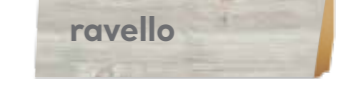
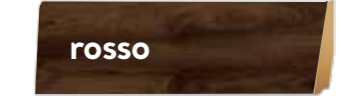



8 MM  
FLOORING  
PARKE

**BELLA NEO**



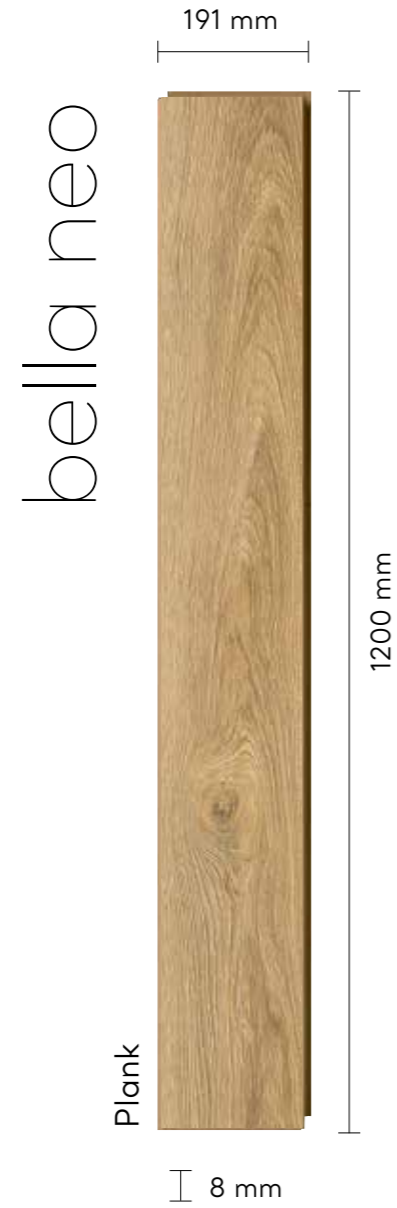

En Width	Boy Length	Kalınlık Thickness	Paket kg Package kg	Paket m <sup>2</sup> Package m <sup>2</sup>
191 mm	1200 mm	8 mm	~16,50	~2,292



Küçük detaylardaki büyük yenilik!

Bazen, bir çiçek gibi ufak bir detay bile ortamın havasını kolayca değiştirir. Bella Neo Parke Serisi'nin yeni doğal yüzeyi ile yaşam alanlarınızı kolayca yenileyin.

*Great innovation in small details!*

*Sometimes, even the smallest detail like a flower, easily changes the mood of the environment. With the new natural surface of Bella Neo Flooring Series Easily refresh your living spaces.*





yeni new  
sardunya

Geçmişin güzelliğinden bir parça!  
Estetik detaylarıyla kendine  
hayran bırakan toprak tonlara  
adım atın.

*A piece of the beauty of the past!  
Take a step into the earthy tones  
that amaze itself with its  
aesthetic details.*

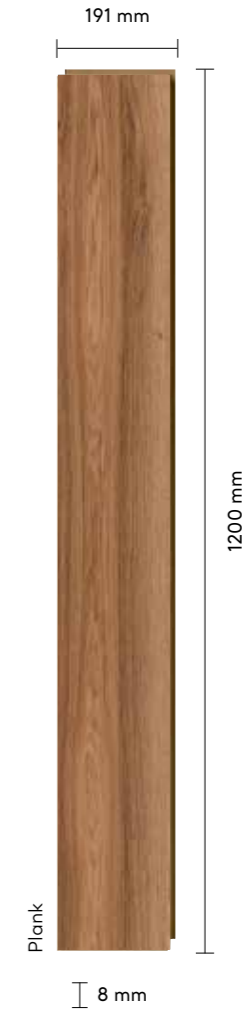

rubio

Sıcak, iç açan toprak tonları!  
Yazın güzelliğini yaşam alanlarınıza taşıyarak doğal bir görünüm yaratın.

Warm, pleasant earth tones!  
Create a natural look by bringing the beauty of summer in your living spaces.



# verona

Romeo ve Juliet'in ölümsüz aşkının kentinden bir kesit! Verona Arena'nın gri beyaz tonlarıyla mekanınızda aşka yer açın.

*A piece from the city of Romeo and Juliet's immortal love! Make room for love in your place with the grey and white tones of Verona Arena.*

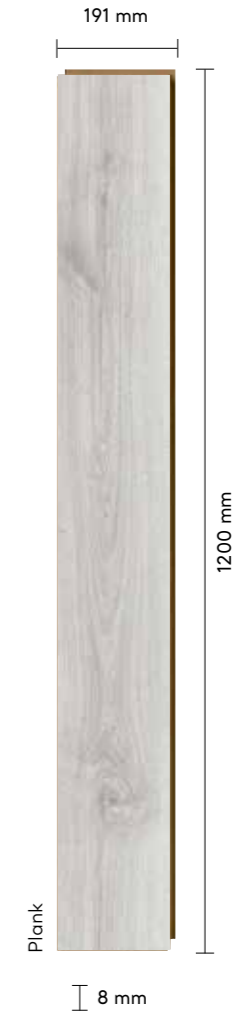



anemon  
anemone

Aradığınız huzur mekanınızda!  
Akdeniz sahillerinin huzuru ve mutluluğunu mekanınıza taşıyın.

*The peace you seek is in your place!  
Bring your place peace and happiness  
of the Mediterranean coast.*

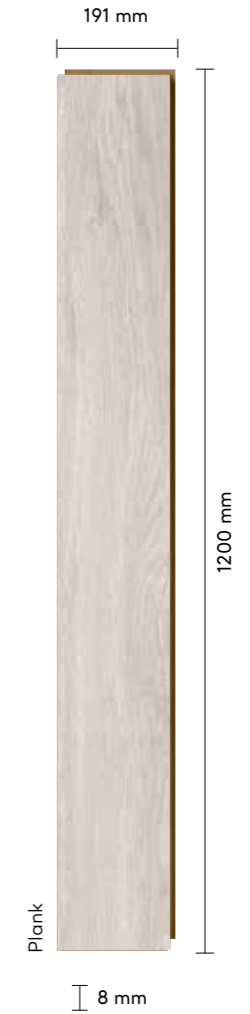

# lilyum lilies

Büyük değişimlerin sırrı,  
küçük detaylarda saklıdır!  
Baharın taze esintileriyle  
mekanınızın havasını değiştirin.

*The secret of big changes  
is hidden in small details!  
Easily change the mood  
of your place with  
the fresh breezes of spring.*

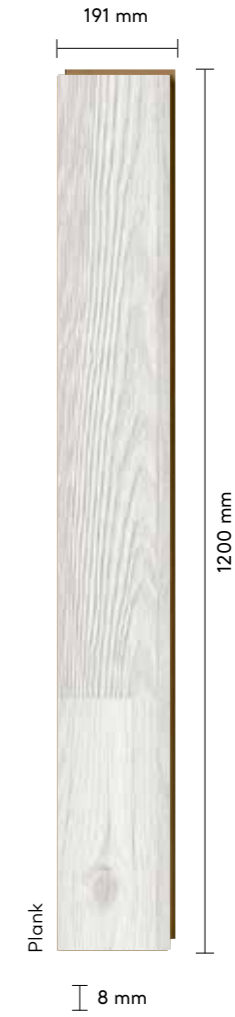



akasya  
acacia

Sıcak, samimi ve doğal!  
Toprak tonlarının narin ve  
belirgin çizgileriyle mekanınızda  
doğayı keşfedin.

*Warm, friendly and natural!  
Discover natural vibes in  
your space with delicate and  
distinctive lines of earth tones.*





# vegas

Ferah ve dalgalı!  
Saf ihtişama sahip dekoruyla  
yaşam alanlarındaki yeniliği  
gözler önüne serin.

*Spacious and wavy!  
Reveals the innovation  
in your spaces with its decor  
that has pure splendor.*

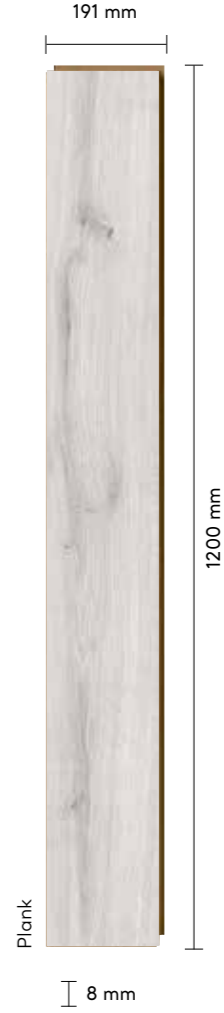



frezya  
freesia

Enerjik ve sıcak!  
Doğanın narin dokusundan  
izlerle yaşam alanlarınızın  
atmosferini değiştirin.

*Energetic and warm!  
Change the atmosphere of  
your spaces with traces  
of nature's delicate texture.*

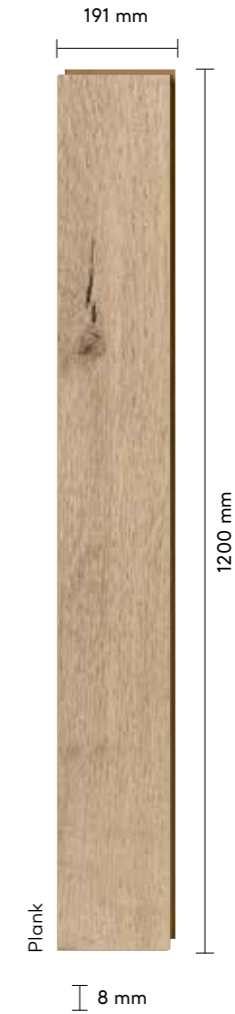



manolya  
magnolia

Asaletin benzersiz tonları!  
Benzersiz kokusuyla akıllarda  
iz bırakan manolyanın güzel  
enerjisini mekanınıza taşıyın.

*Unique shades of nobility!  
Bring your place the beautiful  
energy of magnolia, which  
leaves effect on the minds  
with its unique smell.*





defne  
daphne

Doğayla yakınlaşma zamanı!  
Doğanın sunduğu benzersiz tonları  
mekanınıza yansitin.

*It's time to get closer to nature!  
Reflect the unique and warm  
tones of nature at your place.*





gardenya  
gardenia

Zarafete yer açın!  
Sıcak ve aydınlık dekoruyla  
yaşam alanlarınıza  
narin dokunuşlar ekleyin.

*Make room for grace!  
Add delicate touches to  
your living spaces with  
its warm and bright decor.*





begonya  
begonia

Mekanınızla uyum içinde!  
İlman iklimleri seven ve  
farklı renk skalalarına uyum  
sağlayan dekoruyla  
mekanınızı yenileyin.

*In harmony with your place!  
Renew your space with its  
decor that loves temperate  
climates and adapts to  
different color scales.*

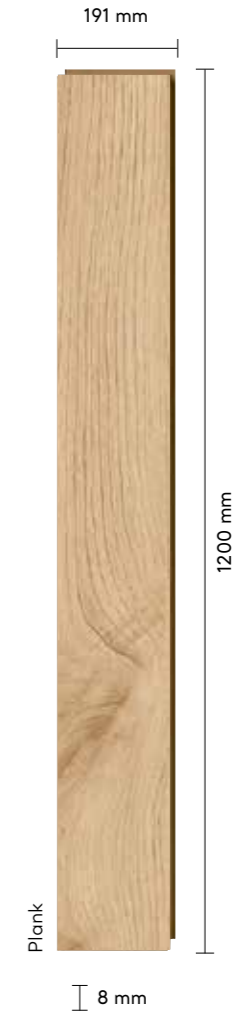

## BELLA NEO TEKNİK ÖZELLİKLER BELLA NEO TECHNICAL SPECIFICATIONS

ÖZELLİKLER / SPECIFICATIONS	STANDART / STANDARD	SONUÇLAR / RESULTS
Elemanlar arası kalınlık farkı;t Thickness difference between elements	EN 13329	T ortalama< 0,50mm t max-tmin<0,50mm T average< 0,50mm t max-t min<0,50mm
Elemanın baş kısım gönye sapması;q Deviation from squareness of element	EN 13329	Q max< 0,2mm
Yüzey tabakasının uzunluğu;1 Length tolerance	EN 13329	1<1500mm 1 fark<0,5mm 1<1500mm 1 difference<0,5mm
Yüzey tabakasının genişliği;w Width tolerance	EN 13329	W ortalama fark 0,10mm w max- w min<0,20mm W average difference 0,10mm w max- w min<0,20mm
Kılıcına dönme miktarı Edgewise bending	EN 13329	0,30 mm
Elemanın yüzey düzgünlüğü Surface smoothness	EN 13329	Fw içbükey <%0,15 fw dışbükey <%0,20 F1 içbükey <%0,50 fl dışbükey <%1,00 Fw concave <%0,15 fw convex <%0,20 F1 concave <%0,50 fl convex <%1,00
Elemanlar arası açıklık;o Space between elements	EN 13329	O ortalama<0,15mm o en büyük 0,15mm O average<0,15mm o max 0,15mm
Elemanlar arası yükseklik farkı;h Height difference between elements	EN 13329	H ortalama< 0,10mm H max<0,15mm H average< 0,10mm H max<0,15mm
Yüzey sağlamlığı;S Surface soundness	EN 13329	AC3 ≥ 1.0 N/mm²
Işık haslığı Light fastness	EN ISO 4892 - 2:200	EN 20105 - A02'ye göre gri ölçekte ≥ 4 maruz kalmayan ve maruz kalan örnek parça arasındaki renk kontrastı Colour contrast between unexposed and exposed sample part ≥ 4 of grey scale according to EN 20105 - A02
Çarpma mukavemeti Impact resistance	EN 13329	23. ve 31. sınıf için IC1 /IC1 for 23rd and 31th class
Koltuk tekerleği etkisi Determination of the effect of a castor chair	EN 425	Görünümde bir değişiklik veya zarar olmayacak No change or damage on appearance should occur
Mobilya ayağı etkisi Determination of the effect of a castor furniture	EN 424	Görülebilir zarar olmamalıdır. No visible damage should occur
Sıcak kaplara dayanıklılık Resistance to hot pots	EN 13329	Sınıf 4 / Class 4
Sigara ateşine karşı dayanıklılık Resistance to cigarette burns fire	EN 13329	Sınıf 4 / Class 4
Su buharına karşı dayanıklılık Resistance to water vapor	EN 13329	Sınıf 4 / Class 4
Leke tutmaya karşı dayanıklılık Stain resistance	EN 13329	Sınıf 5 / Class 5
24 saat suda şişme 24 hours swelling in thickness	EN 13329	<%18
Yoğunluk / Density	EN 325	860-880 kg/m²
Eğilme dayanımı Bending strenght	EN 317	850-900 Kg/m³
Elastikiyet modülü Modulus of elasticity	EN 310	>3500 N/mm²
Çekme dayanımı Vertical internal bond	EN 319	>1,2 N/mm²
Çizilme mukavemeti (N) Scratch resistance	EN 438	> 3,5 N
Aşınma dayanımı Abrasion Resistance	EN 438	Devir / Cycle ≥ 2000

## AŞINMA SINIFLARI/ABRASION CLASSES

BELLA NEO	KONUTLARDA / HOUSES			OFİSLERDE / OFFICES		
	Az / Low	Orta / Medium	Yoğun / High	Az / Low	Orta / Medium	Yoğun / High
	21	22	23	31	32	33
	AC1	AC2	AC3	AC4	AC5	
Ortalama aşınma değeri / Average abrasion value	>2000					

Renkler basılı ve dijital kataloglarda farklılık gösterebilir. Lütfen, satış noktalarımızda bulunan gerçek ürünler ile karşılaştırınız.

Colors may vary in digital and printed catalogs. Please compare with the actual products in the sales points.

**BELLA NEO DEKORLAR**  
BELLA NEO DECORS

Yeni  
New



**BELLA NEO SÜPÜRGELİK DEKORLAR**  
BELLA NEO SKIRTING DECORS

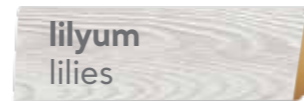
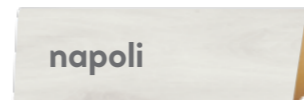

**BELLA NEO DEKORLAR**  
BELLA NEO DECORS

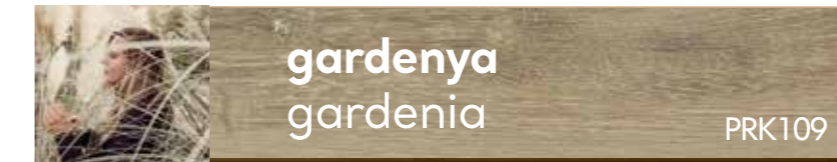

**BELLA NEO SÜPÜRGELİK DEKORLAR**  
BELLA NEO SKIRTING DECORS

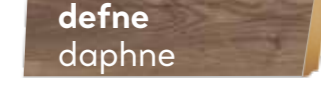
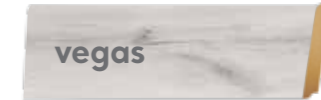



### AGT SÜPÜRGELİK KOLEKSİYONLARI İLE KUSURSUZ MEKANLAR

AGT Süpürgelikler, tüm AGT ürünleri ile mükemmel uyum sağlar.  
Geniş dekor ve model seçenekleri arasından size en uygun  
olanı seçin, mekanınıza yenilik katın.

### *PERFECT SPACES WITH AGT SKIRTING SERIES*

AGT Skirtings perfectly fit with all AGT products.  
Choose the one that suits you best from a wide range  
decor and model options and add innovation to your space.





## SÜPÜRGELİK PROFİLLERİ

### SKIRTING PROFILES

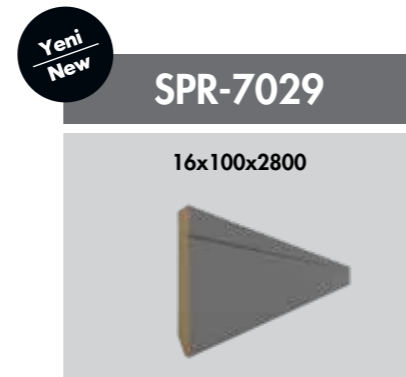
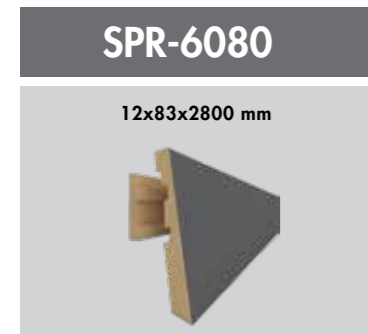
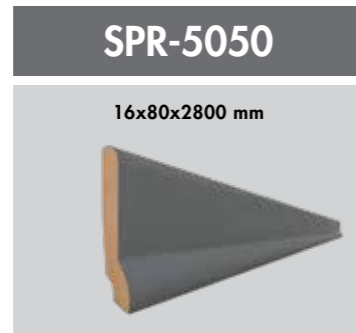
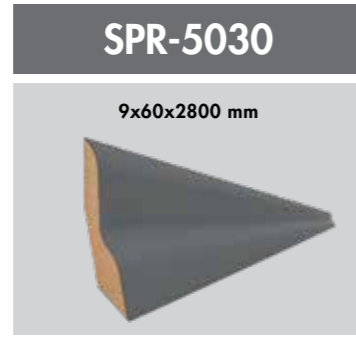

## SÜPÜRGELİK DEKORLAR

### SKIRTING DECORS

#### 1. Grup/Group

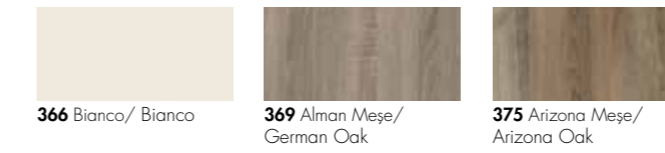
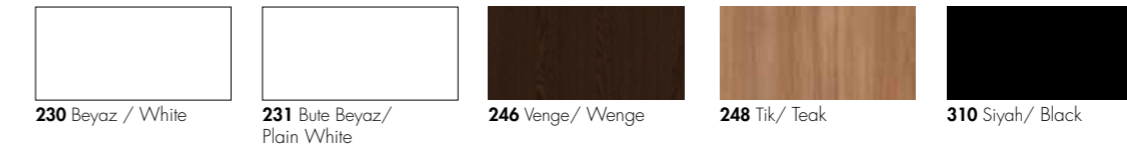

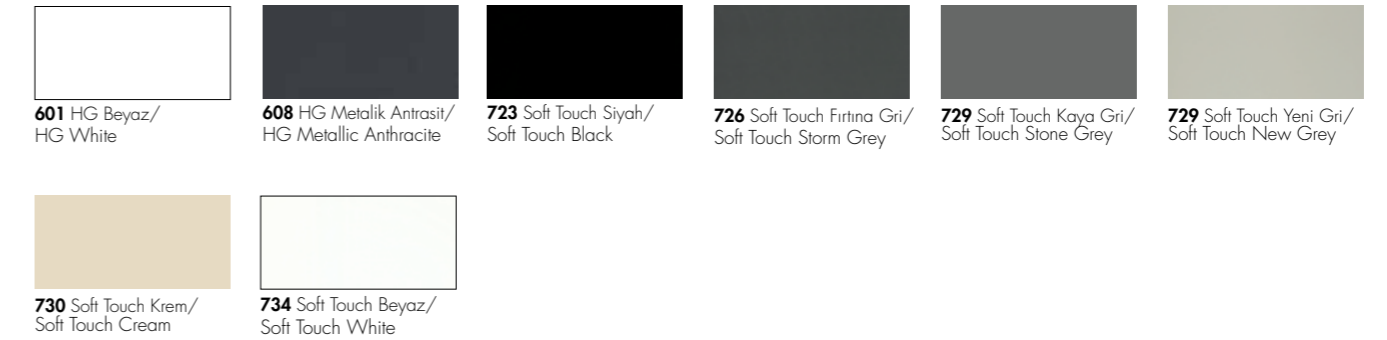

#### 2. Grup/Group



\*Yukarıdaki renklerden stoklu üretim bulunmaktadır.  
\*These colors are produced as stock.

## AGT SÜPÜRGELİK KARKAS MODELLERİ

### AGT SKIRTING CARCASS MODELS

KOD NUMARASI/ CODE NUMBER	ÖLÇÜ (mm)/ MEASUREMENT (mm)	ÜRÜN KESİTİ/ CROSS-SECTION	UYUMLU SÜPÜRGELİKLER/ AVAILABLE SKIRTINGS
SK-2001	10x43x2800		SPR-5070
SK-2000	10x51x2800		SPR-5020 / SPR-5060





# AGT

agt.com.tr